

CATÁLOGO CONEXIONES INDUSTRIALES DE LATÓN





NACOBRE

CONEXIONES INDUSTRIALES DE LATÓN

Catálogo Línea Industrial

Conexiones Industriales Nacobre

Industrias Nacobre líder nacional en producción y manufactura de productos de cobre, presenta su catálogo de la Línea Industrial de conexiones, para aplicaciones tales como : frenos de aire, refrigeración, instrumentación, valvulería, etc.



La planta de **Cobrecel** ubicada en Toluca, Edo. de México cuenta con una capacidad instalada de 500 toneladas por mes, en un área de 9,000 m² , produce toda la gama de conexiones para la industria además de accesorios ; complementando así la línea de tuberías de cobre.



Las conexiones son fabricadas bajo el más riguroso aseguramiento de calidad manteniendo una producción regular capaz de competir a nivel mundial. Nuestras conexiones se fabrican a partir de forja de latón y a partir de barras de latón maquinado.











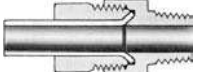

Para su fácil identificación se han dividido en 11 familias. Los números de parte contienen información sobre la familia a la que pertenecen, la configuración y finalmente la medida o medidas de las terminales (ver información para pedido).

Por seguridad solo instale Calidad Nacobre,

Por que cobre es...Nacobre.

Contenido

FIGURA	DESCRIPCIÓN	PÁGINA
 Familia 1	<i>Conexiones abocinadas a 45°</i>	1
 Familia 2	<i>Conexiones con abocinado invertido a 45°</i>	9
 Familia 3	<i>Conexiones con rosca para tubo NPTF</i>	13
 Familia 4	<i>Conexiones a compresión</i>	19
 Familia 5A	<i>Conexiones de frenos de aire para tubo de cobre</i>	26
 Familia 5B	<i>Conexiones de frenos de aire para tubo de nylon</i>	31
 Familia 6	<i>Conexiones reutilizables para frenos de aire (Serie AB y AC)</i>	36
 Familia 7	<i>Conexiones Poly-Con</i>	39
 Familia 8	<i>Coples para manguera , baja presión (serie KA)</i>	45
 Familia 9	<i>Válvulas y Grifos</i>	47
 Familia 10	<i>Conexiones sello perfecto (serie 700)</i>	53
 Familia 11	<i>Conexiones para refrigeración</i>	63

Conexiones para tubo, abocinado a 45°

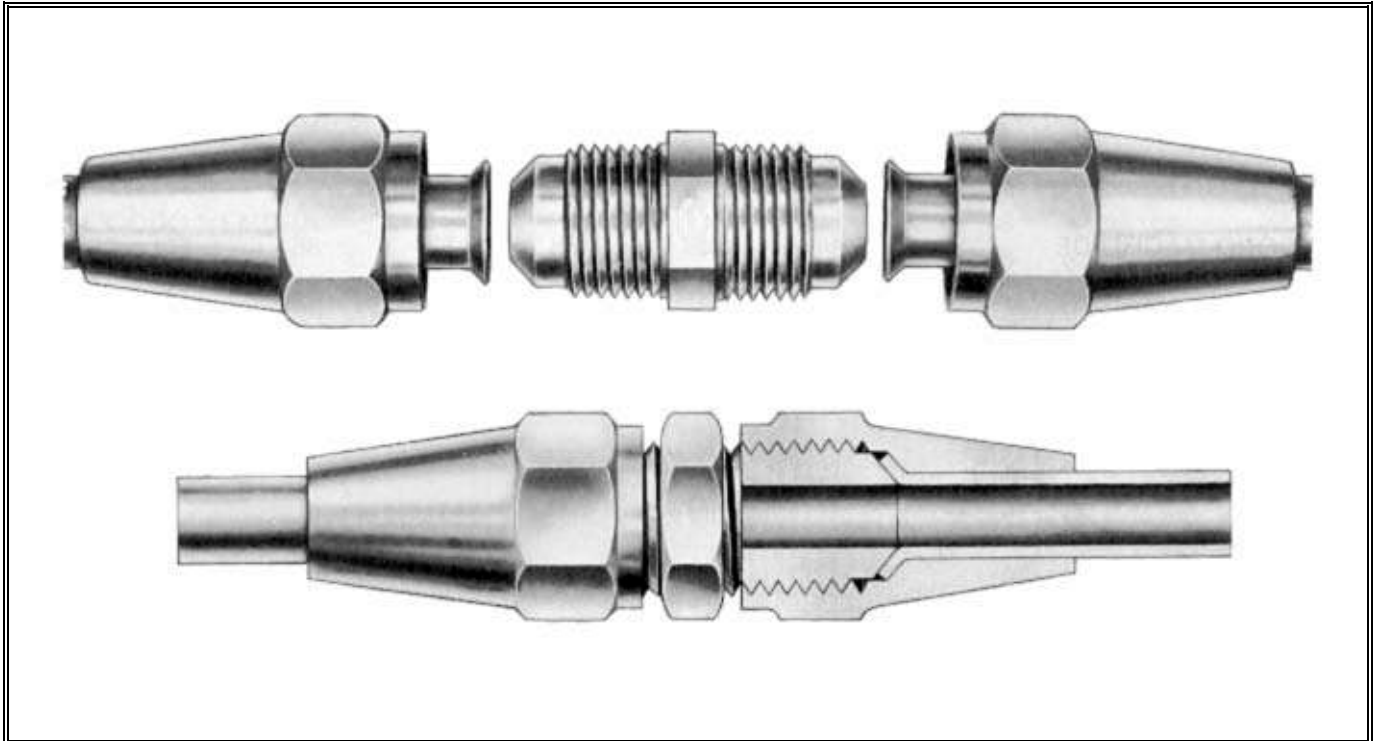

Conexión industrial estándar económica adecuada para servicios que requieren ensambles y desensambles periódicos con una resistencia mecánica excepcional a la tensión (pull out)

TAMAÑO : Tubo : de 1/8" a 3/4" de diámetro exterior.
Terminales de 1/8" a 3/4" NPTF

PRESIÓN MÁXIMA DE OPERACIÓN : 7, 000 PSI (492 kg/cm²) dependiendo del tubo usado

MATERIALES : Codos y Tes :
Latón forjado
SAE CA 377
Conectores, uniones, y tuercas : SAE CA 360

COMPATIBILIDAD : Cobre, Aluminio, Latón, acero blando de paredes delgadas sin costura

ESPECIFICACIONES :

S. A. E. : Cumple S. A. E. J512 Norma de tubo y conexiones automotrices

A. N. S. I. - B31.1 Código para tubería de presión

A. S. M. E. -Código para calderas y ollas de presión

Conexiones para tubo, abocinado a 45°



IDEAL PARA SERVICIO DE ALTA PRESIÓN.

Las conexiones abocinadas a 45° Nacobre son adecuadas para servicios que requieren una resistencia excepcional a la tensión mecánica.

Se usan especialmente cuando la conexión está sujeta a frecuentes reinstalaciones así como a repetitivos ajustes de las tuercas. La función real del abocinado del tubo amordazado entre la tuerca y el cuerpo, es la de proporcionar seguridad y confiabilidad absolutas.

APLICACIONES.

Ampliamente usadas en líneas de alta, mediana y baja presión que no están sujetas a una excesiva vibración o movimiento de la tubería. Se ha comprobado su efectividad en equipo móvil, maquinaria, compresores de aire, quemadores de petróleo, equipos de refrigeración y aire acondicionado y aplicaciones marinas.

VIBRACIÓN.

La tuerca corta es usada en casos de vibración mínima. En otros casos debe usarse la tuerca larga que ofrece una mayor resistencia.

ABOCINADO SENCILLO O DOBLE.

La tubería puede tener "campana sencilla" o "doble" para un máximo de confiabilidad. Se recomienda la bocina doble para tubería de acero Bundy o semejante, para asegurarse de que no se raje o se abra el tubo al abocinarlo. En la actualidad, el abocinado sencillo se usa con más frecuencia para conexiones con tubo de aluminio y cobre.

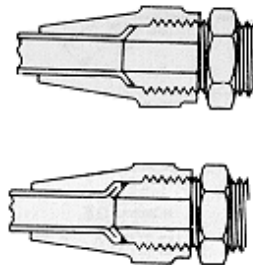

EL DOBLE ABOCINADO PERMITE UN PAR DE APRIETE MAYOR

Una de las ventajas del doble abocinado es que permite un mayor par de apriete sin que el abocinado se planche o se desgaste en exceso. El doble abocinado compensa este par manteniendo un sello eficaz.

Otra ventaja es, que es adecuado para uniones de tubería en donde se requiere frecuentes reinstalaciones especialmente en tubos de 3/8" de diámetro exterior o menores.

Conexiones para tubo, abocinado a 45°

TAMAÑOS RECOMENDADOS PARA BOCINAS SENCILLAS SAE

Diámetro exterior	Tubo	1/8"	3/16"	1/4"	5/16"	3/8"	1/2"	5/8"	3/4"	4/8"
Campana	Máx.	.200	.280	.360	.430	.490	.660	.790	.950	1.070
Diámetro (A)	Min	.180	.260	.340	.400	.460	.630	.760	.920	1.040
Radio		.03	.03	.03	.03	.04	.06	.06	.08	.08

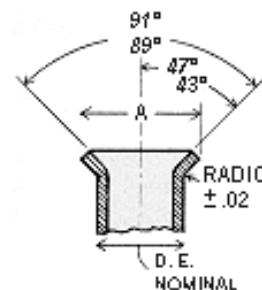

PRESIONES MÁXIMAS DE OPERACIÓN RECOMENDADAS (PSI)

MATERIAL DE LAS CONEXIONES :
LATÓN

MATERIAL DE LA TUBERÍA : ACERO
SAE 1010 - ACERO BLANDO Y ACERO SOLDADO

CONDICIONES DE SERVICIO	DIAM. EXT.	TIPO DE TUBERÍA Y GROSOR DE PARED									
		ACERO SAE 1010 BLANDO ESTIRADO EN FRÍO (SIN COSTURA)					ACERO SOLDADO* (BUNDY O GM) (RECOCIDO)				
		.032"	.035	.049	.065	.083	.095	.028	.032	.035	.049
Factor de Seguridad 4-1	1/8"	7,000					6,000				
	3/16"	4,600					4,100				
	1/4"		3,800				3,100	3,500			
	5/16"		3,000	4,300			2,600	2,800			
	3/8"		2,500	3,600			2,000	2,350	2,500		
	1/2"		1,900	2,650	3,500				1,900	2,700	
	5/8"			2,100	2,800	3,600			1,550	2,100	
	3/4"			1,800	2,300		3,400				
	7/8"			2,000	2,500						
Factor de Seguridad 6-1	1/8"	4,600					4,150				
	3/16"	3,000					2,750				
	1/4"		2,500				2,050	2,350			
	5/16"		2,000	2,850			1,750	1,900			
	3/8"		1,700	2,400			1,350	1,550	1,700		
	1/2"		1,250	1,750	2,300				1,250	1,800	
	5/8"			1,400	1,900	2,400			1,000	1,400	
	3/4"			1,200	1,550		2,150				
	7/8"			1,350	1,650						

* Campana de doble abocinado

Conexiones para tubo, abocinado a 45°

PRESIONES MÁXIMAS DE OPERACIÓN RECOMENDADAS (PSI)

MATERIAL DE LAS CONEXIONES :
LATÓN

MATERIAL DE LA TUBERÍA :
COBRE BLANDO Y COBRE MEDIO DURO

CONDICIONES DE SERVICIO	DIAM. EXT.	TIPO DE TUBERÍA Y GROSOR DE PARED									
		COBRE BLANDO (SIN COSTURA)					COBRE MEDIO DURO (SIN COSTURA)				
		.032"	.035	.049	.065	.083	.095	.028	.032	.035	.049
Factor de Seguridad 4-1	1/8"	4,300		5,000			5,000				
	3/16"	2,850		3,300			3,400				
	1/4"	2,100	2,250	2,500			2,500				
	5/16"		1,800	2,000			2,000				
	3/8"		1,500	1,650			1,700	1,850			
	1/2"		1,100	1,250		2,000	1,250	1,400			2,600
	5/8"			1,000	1,400	1,800	1,000			1,500	2,000
	3/4"			850	1,150	1,500			1,100		1,700
7/8"									1,100	1,500	
Factor de Seguridad 6-1	1/8"	2,800		3,350			3,400				
	3/16"	1,900		2,200			2,250				
	1/4"	1,430	1,500	1,650			1,700				
	5/16"		1,200	1,300			1,350				
	3/8"		1,000	1,100			1,100	1,200			
	1/2"		750	825		1,550	850	925			1,750
	5/8"			650	930	1,200	675			1,000	1,350
	3/4"			550	775	1,000			725		1,100
7/8"									750	1,000	

ROSCAS PARA TUBOS

Rosca cónica para tubo Drysel American Standard

INFORMACIÓN PARA PEDIDO

Para hacer un pedido, simplemente indique el número de catálogo y agregue el diámetro exterior y el tamaño de la terminal con rosca para tubo en caso necesario. Las tuercas deben pedirse por separado.

EJEMPLO :

3/8" (6/16") diámetro exterior x rosca macho para tubo de 1/4" (4/16")
48-F-0604

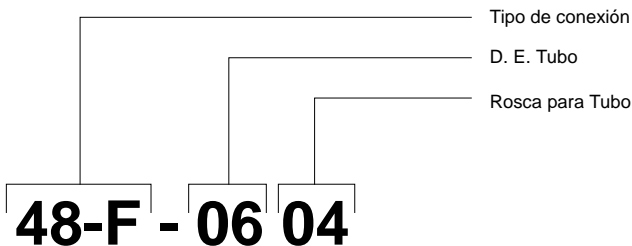

Conexiones para tubo, abocinado a 45°

DIMENSIONES DEL ABOCINADO

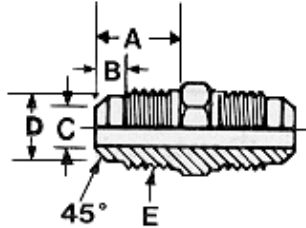
	Diámetro Exterior del tubo	A	B	C	D	Rosca E
	1/8"	0.38	0.12	0.109	0.234	5/16-24
3/16"	0.44	0.12	0.156	0.297	3/8-24	
1/4"	0.50	0.16	0.219	0.344	7/16-20	
5/16"	0.56	0.19	0.250	0.406	1/2-20	
3/8"	0.62	0.22	0.312	0.531	5/8-18	
1/2"	0.75	0.25	0.438	0.641	3/4-16	
5/8"	0.88	0.28	0.531	0.750	7/8-14	
3/4"	1.00	0.28	0.719	0.938	1 1/16-14	
7/8"	1.12	0.38	0.797	1.125	1 1/4-12	

Conexiones para tubo, abocinado a 45°

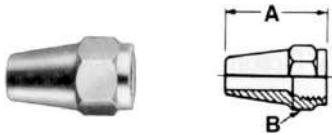
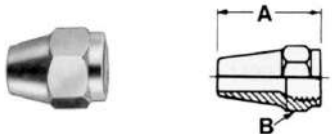
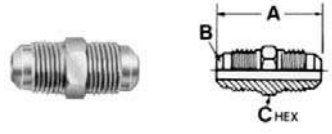
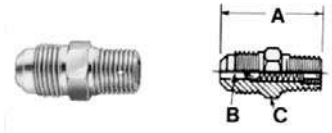
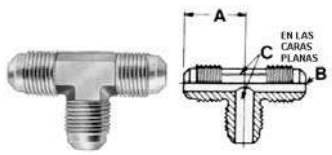
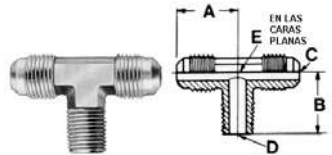
	Número de catálogo	D. E. Tubo	Rosca Tubo NPTF	A	B	C	D	E	F	
41-F TUERCA CÓNICA LARGA 	41-F-02	1/8		0.750	0.375					
	41-F-03	3/16		0.810	0.437					
	41-F-04	1/4		0.940	0.562					
	41-F-05	5/16		1.120	0.625					
	41-F-06	3/8		1.310	0.750					
	41-F-08	1/2		1.620	0.875					
	41-F-10	5/8		1.880	1.062					
	41-F-12	3/4		2.190	1.250					
	41-FS TUERCA CÓNICA CORTA 	41-FS-02	1/8		0.500	0.375				
		41-FS-03	3/16		0.620	0.437				
41-FS-04		1/4		0.750	0.562					
41-FS-05		5/16		0.880	0.625					
41-FS-06		3/8		1.000	0.750					
41-FS-08		1/2		1.120	0.875					
41-FS-10		5/8		1.310	1.062					
41-FS-12		3/4		1.500	1.250					
42-F NIPLE UNIÓN 		42-F-02	1/8		0.920	0.078	0.312			
		42-F-03	3/16		1.060	0.125	0.375			
	42-F-04	1/4		1.190	0.188	0.437				
	42-F-05	5/16		1.340	0.219	0.500				
	42-F-06	3/8		1.500	0.281	0.625				
	42-F-08	1/2		1.810	0.406	0.750				
	42-F-10	5/8		2.120	0.500	0.875				
	42-F-12	3/4		2.440	0.625	1.062				
	43-F NIPLE CHECK 	43-F-0402	1/4	1/8	1.060	0.136	0.438			
		43-F-0404	1/4	1/4	1.250	0.136	0.562			
43-F-0502		5/16	1/8	1.160	0.136	0.500				
43-F-0504		5/16	1/4	1.340	0.136	0.562				
43-F-0604		3/8	1/4	1.440	0.187	0.625				
44-F TE UNIÓN 		44-F-02	1/8		0.620	0.078	0.312			
	44-F-03	3/16		0.750	0.125	0.375				
	44-F-04	1/4		0.880	0.188	0.375				
	44-F-05	5/16		0.910	0.219	0.437				
	44-F-06	3/8		1.060	0.281	0.500				
	44-F-08	1/2		1.220	0.406	0.625				
	44-F-10	5/8		1.410	0.500	0.812				
	44-F-12	3/4		1.660	0.625	1.000				
	45-F TE TERMINAL MACHO AL CENTRO 	45-F-0302	3/16	1/8	0.750	0.750	0.125	0.219	0.290	
		45-F-0402	1/4	1/8	0.810	0.780	0.188	0.219	0.375	
45-F-0404		1/4	1/4	0.910	0.940	0.188	0.312	0.437		
45-F-0502		5/16	1/8	0.910	0.780	0.219	0.219	0.500		
45-F-0504		5/16	1/4	0.970	0.940	0.219	0.281	0.500		
45-F-0604		3/8	1/4	1.030	1.060	0.281	0.312	0.500		
45-F-0606		3/8	3/8	1.060	1.090	0.281	0.406	0.625		
45-F-0608		3/8	1/2	1.250	1.380	0.281	0.562	0.625		
45-F-0806		1/2	3/8	1.220	1.120	0.406	0.406	0.625		
45-F-0808		1/2	1/2	1.280	1.380	0.406	0.562	0.812		
45-F-1008		5/8	1/2	1.410	1.380	0.500	0.562	0.812		
45-F-1208		3/4	1/2	1.620	1.500	0.625	0.562	1.000		

Conexiones para tubo, abocinado a 45°

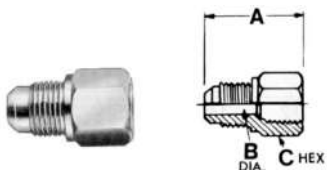
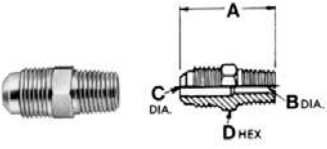
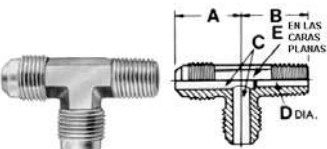
	Número de catálogo	D. E. Tubo	Rosca Tubo NPTF	A	B	C	D	E	F
46-F CAMPANA NIPLE HEMBRA 	46-F-0202	1/8	1/8	0.910	0.078	0.562			
	46-F-0302	3/16	1/8	0.970	0.125	0.562			
	46-F-0402	1/4	1/8	1.030	0.188	0.562			
	46-F-0404	1/4	1/4	1.250	0.188	0.688			
	46-F-0406	1/4	3/8	1.280	0.188	0.812			
	46-F-0502	5/16	1/8	1.060	0.219	0.562			
	46-F-0504	5/16	1/4	1.280	0.219	0.688			
	46-F-0602	3/8	1/8	1.120	0.281	0.625			
	46-F-0604	3/8	1/4	1.310	0.281	0.688			
	46-F-0606	3/8	3/8	1.380	0.281	0.812			
	46-F-0608	3/8	1/2	1.620	0.281	1.000			
	46-F-0612	3/8	3/4	1.660	0.281	1.250			
	46-F-0804	1/2	1/4	1.410	0.406	0.750			
	46-F-0806	1/2	3/8	1.500	0.406	0.812			
	46-F-0808	1/2	1/2	1.750	0.406	1.000			
	46-F-0812	1/2	3/4	1.810	0.406	1.250			
	46-F-1006	5/8	1/4	1.590	0.500	0.875			
	46-F-1008	5/8	1/2	1.810	0.500	1.000			
	46-F-1012	5/8	3/4	1.910	0.500	1.250			
	46-F-1208	3/4	1/2	1.910	0.625	1.062			
46-F-1212	3/4	3/4	1.970	0.625	1.250				
48-F NIPLE TERMINAL MACHO 	48-F-0202	1/8	1/8	0.920	0.219	0.078	0.438		
	48-F-0302	3/16	1/8	1.000	0.219	0.125	0.438		
	48-F-0402	1/4	1/8	1.060	0.219	0.188	0.438		
	48-F-0404	1/4	1/4	1.250	0.312	0.188	0.562		
	48-F-0406	1/4	3/8	1.310	0.406	0.188	0.688		
	48-F-0408	1/4	1/2	1.560	0.562	0.188	0.875		
	48-F-0502	5/16	1/8	1.160	0.219	0.219	0.500		
	48-F-0504	5/16	1/4	1.340	0.312	0.219	0.562		
	48-F-0602	3/8	1/8	1.250	0.219	0.281	0.625		
	48-F-0604	3/8	1/4	1.440	0.312	0.281	0.625		
	48-F-0606	3/8	3/8	1.440	0.406	0.281	0.688		
	48-F-0608	3/8	1/2	1.690	0.562	0.281	0.875		
	48-F-0612	3/8	3/4	1.810	0.750	0.281	1.062		
	48-F-0804	1/2	1/4	1.620	0.312	0.406	0.750		
	48-F-0806	1/2	3/8	1.620	0.406	0.406	0.750		
	48-F-0808	1/2	1/2	1.810	0.562	0.406	0.875		
	48-F-0812	1/2	3/4	1.940	0.750	0.406	1.062		
	48-F-1004	5/8	1/4	1.810	0.312	0.500	0.875		
	48-F-1006	5/8	3/8	1.810	0.406	0.500	0.875		
	48-F-1008	5/8	1/2	2.000	0.562	0.500	0.875		
48-F-1012	5/8	3/4	2.060	0.750	0.500	1.062			
48-F-1208	3/4	1/2	2.190	0.562	0.625	1.062			
48-F-1212	3/4	3/4	2.190	0.750	0.625	1.062			
51-F TE TERMINAL MACHO LATERAL 	51-F-0302	3/16	1/8	0.750	0.750	0.125	0.219	0.375	
	51-F-0402	1/4	1/8	0.880	0.780	0.188	0.219	0.375	
	51-F-0404	1/4	1/4	0.910	0.940	0.188	0.281	0.500	
	51-F-0502	5/16	1/8	0.910	0.780	0.219	0.219	0.438	
	51-F-0504	5/16	1/4	0.970	0.940	0.219	0.312	0.500	
	51-F-0604	3/8	1/4	1.060	1.060	0.281	0.312	0.500	
	51-F-0606	3/8	3/8	1.060	1.090	0.281	0.406	0.625	
	51-F-0608	3/8	1/2	1.060	1.380	0.281	0.562	0.937	
	51-F-0806	1/2	3/8	1.220	1.120	0.406	0.406	0.625	
	51-F-0808	1/2	1/2	1.280	1.380	0.406	0.562	0.812	
51-F-1008	5/8	1/2	1.410	1.500	0.500	0.562	0.812		

Conexiones para tubo, abocinado a 45°

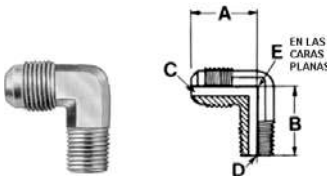
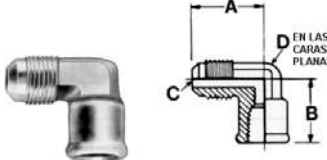
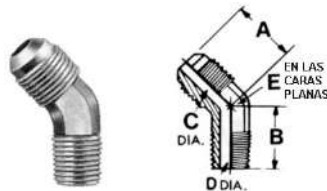
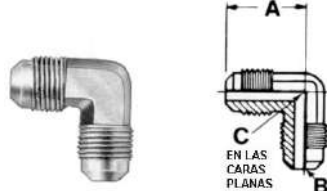
	Número de catálogo	D. E. Tubo	Rosca Tubo NPTF	A	B	C	D	E	F
49-F CODO 90° TERMINAL MACHO 	49-F-0202	1/8	1/8	0.650	0.690	0.078	0.219	0.375	
	49-F-0302	3/16	1/8	0.750	0.750	0.125	0.219	0.406	
	49-F-0402	1/4	1/8	0.825	0.780	0.188	0.219	0.406	
	49-F-0404	1/4	1/4	0.910	0.940	0.188	0.312	0.500	
	49-F-0406	1/4	3/8	0.940	1.030	0.188	0.406	0.625	
	49-F-0502	5/16	1/8	0.910	0.780	0.219	0.219	0.437	
	49-F-0504	5/16	1/4	0.970	0.940	0.219	0.312	0.437	
	49-F-0506	5/16	3/8	1.000	1.030	0.219	0.406	0.562	
	49-F-0602	3/8	1/8	1.030	0.910	0.281	0.219	0.500	
	49-F-0604	3/8	1/4	1.000	1.060	0.281	0.312	0.500	
	49-F-0606	3/8	3/8	1.060	1.090	0.281	0.406	0.562	
	49-F-0608	3/8	1/2	1.160	1.280	0.281	0.500	0.750	
	49-F-0612	3/8	3/4	1.250	1.280	0.281	0.750	0.937	
	49-F-0804	1/2	1/4	1.250	1.120	0.406	0.312	0.687	
	49-F-0806	1/2	3/8	1.220	1.120	0.406	0.406	0.625	
	49-F-0808	1/2	1/2	1.280	1.380	0.406	0.562	0.812	
	49-F-0812	1/2	3/4	1.410	1.410	0.406	0.750	1.000	
	49-F-1006	5/8	3/8	1.410	1.250	0.500	0.406	0.750	
	49-F-1008	5/8	1/2	1.410	1.380	0.500	0.562	0.812	
	49-F-1012	5/8	3/4	1.470	1.500	0.500	0.750	0.937	
49-F-1208	3/4	1/2	1.620	1.500	0.625	0.562	0.937		
49-F-1212	3/4	3/4	1.620	1.620	0.625	0.750	1.000		
50-F CODO 90° TERMINAL HEMBRA 	50-F-0302	3/16	1/8	0.812	0.440	0.125	0.562		
	50-F-0402	1/4	1/8	0.880	0.470	0.188	0.562		
	50-F-0404	1/4	1/4	0.970	0.660	0.188	0.688		
	50-F-0502	5/16	1/8	0.940	0.470	0.219	0.562		
	50-F-0504	5/16	1/4	1.030	0.660	0.219	0.688		
	50-F-0604	3/8	1/4	1.090	0.690	0.281	0.688		
	50-F-0606	3/8	3/8	1.160	0.690	0.281	0.875		
	50-F-0608	3/8	1/2	1.250	0.880	0.281	1.000		
	50-F-0806	1/2	3/8	1.280	0.750	0.406	1.000		
	50-F-0808	1/2	1/2	1.380	0.940	0.406	1.000		
	50-F-1008	5/8	1/2	1.500	1.000	0.500	1.000		
50-F-1208	3/4	1/2	1.620	1.060	0.625	1.125			
54-F CODO 45° TERMINAL MACHO 	54-F-0302	3/16	1/8	0.625	0.656	0.125	0.218	0.437	
	54-F-0402	1/4	1/8	0.687	0.656	0.187	0.218	0.437	
	54-F-0404	1/4	1/4	0.750	0.875	0.187	0.281	0.500	
	54-F-0502	5/16	1/8	0.750	0.656	0.218	0.218	0.437	
	54-F-0504	5/16	1/4	0.720	0.860	0.218	0.312	0.437	
	54-F-0604	3/8	1/4	0.875	0.875	0.281	0.281	0.500	
	54-F-0606	3/8	3/8	0.875	0.875	0.281	0.281	0.500	
	54-F-0806	1/2	3/8	1.000	0.875	0.406	0.406	0.625	
	54-F-1008	5/8	1/2	1.125	1.156	0.500	0.562	0.812	
	54-F-1208	3/4	1/2	1.312	1.218	0.625	0.562	1.062	
	55-F CODO 90° UNIÓN 	55-F-02	1/8		0.620	0.078	0.500		
55-F-03		3/16		0.750	0.125	0.437			
55-F-04		1/4		0.880	0.188	0.437			
55-F-05		5/16		0.940	0.219	0.437			
55-F-06		3/8		1.060	0.281	0.500			
55-F-08		1/2		1.250	0.406	0.687			
55-F-10		5/8		1.440	0.500	0.812			
55-F-12		3/4		1.690	0.625	1.000			

Abocinado a 45° invertido

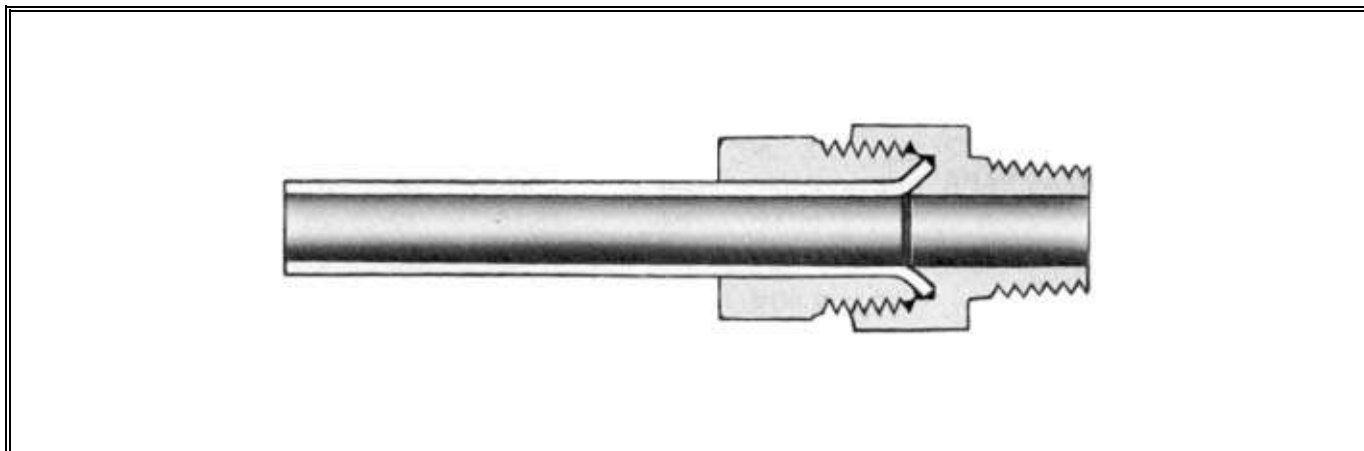

Abocinado regular de 45°, salvo que el asiento del abocinado está dentro del cuerpo. Están protegidos, el asiento y la rosca. Para tubería de cobre, aluminio, y acero Bundy, GM o Avon.

PRESIONES MÁXIMAS DE OPERACIÓN RECOMENDADAS (PSI)

MATERIAL DE LAS CONEXIONES :
MATERIAL DE LA TUBERÍA :

LATÓN
COBRE BLANDO Y COBRE MEDIO DURO

CONDICIONES DE SERVICIO	DIAM. EXT.	TIPO DE TUBERÍA Y GROSOR DE PARED									
		COBRE BLANDO (SIN COSTURA)					COBRE MEDIO DURO (SIN COSTURA)				
		.030"	.032	.035	.049	.065	.032	.035	.042	.049	.065
PRESIÓN ESTÁTICA Vibración mínima de la línea	1/8"	2,100		2,500			2,500				
	3/16"	1,400		1,650			1,700				
	1/4"	1,050	1,100	1,250			1,250				
	5/16"		900	1,000			1,000				
	3/8"		750	825			850	925			
	1/2"		575	625		1,150	650	700			1,300
	5/8"		500	700	900	500			775	1,000	

Abocinado a 45° invertido

MATERIAL DE LAS CONEXIONES : LATÓN
MAT. DE LA TUBERÍA : ACERO RECOCIDO*

CONDICIONES DE SERVICIO	DIAM EXT.	TIPO DE TUBERÍA Y GROSOR DE PARED			
		ACERO RECOCIDO			
		.028"	.032	.035	.049
PRESIÓN ESTÁTICA Vibración mínima de la línea	1/8"	2,500			
	3/16"	2,000			
	1/4"	1,550	1,750		
	5/16"	1,300	1,400		
	3/8"	1,000	1,150	1,250	
	1/2"			950	1,350
	5/8"		775	1,050	

* Campana de doble abocinado

MATERIALES

- Codos y tes : piezas forjadas de latón - SAE CA 377
- Conectores, uniones y tuercas No. 41-WB : - SAE CA 360 o similar

ROSCAS PARA TUBOS

Rosca larga para tubo Drysel American Standard

INFORMACIÓN PARA PEDIDO

Para hacer un pedido, simplemente indique el número de catálogo y agregue la medida deseada y el tamaño de la terminal con rosca para tubo en caso necesario. Las tuercas deben pedirse por separado.

EJEMPLO :

Tubo de diámetro exterior 3/8" (**6/16"**) x rosca macho para tubo de 1/4" (**4/16"**)
 48-W-0604

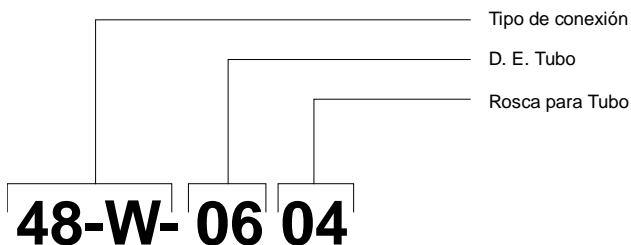

DIMENSIONES DEL ABOCINADO

	Diámetro Exterior del tubo	Rosca				
		A	B	C	D	E
	1/8"	5/16-28	0.104	0.218	0.187	0.250
	3/16"	3/8-24	0.151	0.265	0.203	0.266
	1/4"	7/16-24	0.214	0.328	0.203	0.266
	5/16"	1/2-20	0.276	0.390	0.234	0.297
	3/8"	5/8-18	0.342	0.484	0.266	0.344
	1/2"	3/4-18	0.467	0.609	0.312	0.391
	5/8"	7/8-18	0.592	0.734	0.328	0.406
	3/4"	1 1/16-16	0.703	0.903	0.359	0.469

Abocinado a 45° invertido

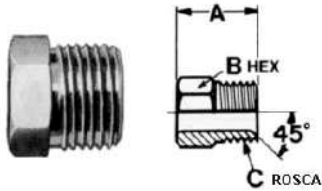
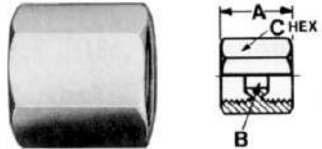
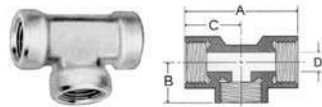
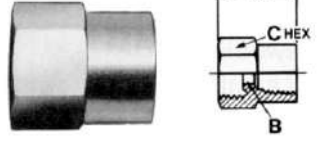
	Número de catálogo	D. E. Tubo	Rosca Tubo NPTF	A	B	C	D	E	F
41-WB TUERCA 	41-WB-02	1/8		0.520	0.312	5/16 - 28			
	41-WB-03	3/16		0.560	0.375	3/8 - 24			
	41-WB-04	1/4		0.560	0.437	7/16 - 24			
	41-WB-05	5/16		0.620	0.500	1/2 - 20			
	41-WB-06	3/8		0.660	0.625	5/8 - 18			
	41-WB-08	1/2		0.740	0.750	3/4 - 18			
	41-WB-10	5/8		0.800	0.875	7/8 - 18			
42-W UNIÓN 	42-W-02	1/8		0.590	0.078	0.406			
	42-W-03	3/16		0.620	0.125	0.468			
	42-W-04	1/4		0.620	0.188	0.531			
	42-W-05	5/16		0.700	0.219	0.593			
	42-W-06	3/8		0.800	0.281	0.750			
	42-W-08	1/2		0.910	0.406	0.906			
44-W TE UNIÓN 	44-W-03	3/16		1.093	0.546	0.125			
	44-W-04	1/4		1.124	0.562	0.187			
	44-W-05	5/16		1.250	0.625	0.218			
	44-W-06	3/8		1.468	0.734	0.281			
	44-W-08	1/2		1.750	0.875	0.406			
46-W CONECTOR HEMBRA 	46-W-0302	3/16	1/8	0.750	0.125	0.500			
	46-W-0402	1/4	1/8	0.750	0.188	0.531			
	46-W-0502	5/16	1/8	0.780	0.219	0.593			
	46-W-0604	3/8	1/4	1.030	0.281	0.750			

Abocinado a 45° invertido

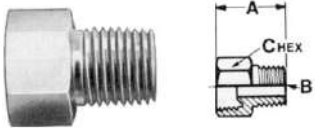
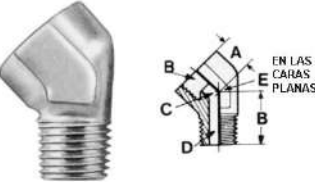
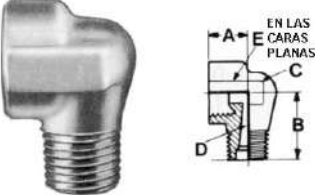
	Número de catálogo	Hembra D. E. Tubo	Macho D. E. Tubo	A	B	C	D	E	F
48-W CONECTOR MACHO 	48-W-0202	1/8	1/8	0.620	0.078	0.406			
	48-W-0302	3/16	1/8	0.690	0.125	0.468			
	48-W-0402	1/4	1/8	0.730	0.188	0.531			
	48-W-0404	1/4	1/4	0.937	0.187	0.562			
	48-W-0502	5/16	1/8	0.780	0.219	0.593			
	48-W-0504	5/16	1/4	0.970	0.219	0.593			
	48-W-0602	3/8	1/8	0.875	0.218	0.718			
	48-W-0604	3/8	1/4	1.020	0.281	0.750			
	48-W-0606	3/8	3/8	1.031	0.281	0.687			
	48-W-0804	1/2	1/4	1.070	0.344	0.937			
	48-W-0806	1/2	3/8	1.060	0.406	0.906			
	48-W-1008	5/8	1/2	1.310	0.531	1.062			
94-W CODO 45° TERMINAL MACHO 	94-W-0302	3/16	1/8	0.312	0.500	0.125	0.156	0.562	
	94-W-0402	1/4	1/8	0.312	0.500	0.187	0.187	0.562	
	94-W-0502	5/16	1/8	0.375	0.562	0.218	0.218	0.625	
	94-W-0504	5/16	1/4	0.375	0.890	0.281	0.281	0.625	
	94-W-0604	3/8	1/4	0.437	0.750	0.281	0.281	0.812	
	94-W-0806	1/2	3/8	0.562	0.812	0.406	0.406	0.937	
49-W CODO 90° TERMINAL MACHO 	49-W-0202	1/8	1/8	0.375	0.625	0.078	0.128	0.500	
	49-W-0302	3/16	1/8	0.375	0.625	0.125	0.128	0.500	
	49-W-0402	1/4	1/8	0.390	0.687	0.187	0.180	0.562	
	49-W-0404	1/4	1/4	0.406	0.781	0.187	0.187	0.625	
	49-W-0502	5/16	1/8	0.453	0.718	0.218	0.218	0.625	
	49-W-0504	5/16	1/4	0.453	0.781	0.218	0.218	0.625	
	49-W-0602	3/8	1/8	0.531	0.843	0.281	0.187	0.812	
	49-W-0604	3/8	1/4	0.531	0.875	0.281	0.250	0.812	
	49-W-0606	3/8	3/8	0.500	0.968	0.281	0.281	0.812	
	49-W-0806	1/2	3/8	0.625	1.062	0.406	0.406	0.937	
	49-W-1008	5/8	1/2	1.187	1.375	0.531	0.531	0.875	

Rosca para tubo NPTF

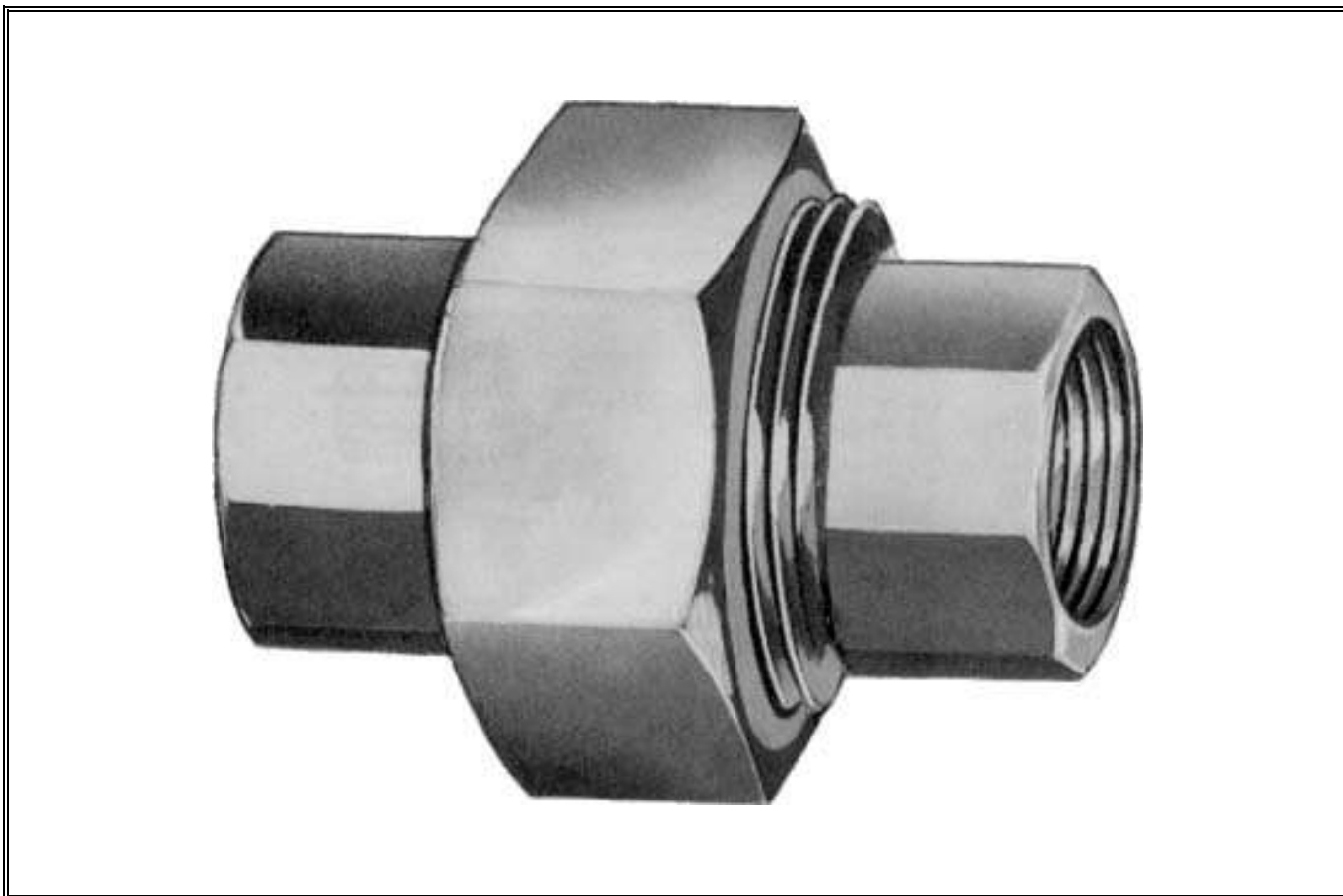

Compactas y fáciles de instalar con llave de tuercas.

TAMAÑO : 1/8" a 3/4" NPTF (Latón)

PRESIÓN MÁXIMA DE OPERACIÓN : 3,000 PSI
(211 kg/cm²)
ver la información específica más adelante

MATERIALES : Codos y Tes :
Latón forjado
Conectores, uniones, y
tuercas : SAE CA 360

Las conexiones para tubo Nacobre son mucho más compactas y fáciles de instalar que las conexiones comunes y corrientes. Las caras para llave de tuercas en los codos y tes facilitan su instalación

INFORMACIÓN PARA PEDIDOS

Para pedidos especifique el número de catálogo para la configuración y medidas deseadas

MATERIALES :

- Codos, tes y cruces : piezas forjadas de latón SAE CA377
- Conexiones rectas : Barra aliviada de esfuerzos - SAE CA360

Rosca para tubo NPTF

PRESIÓN MÁXIMA DE OPERACIÓN RECOMENDADAS.

Tamaño de 1/8" a 3/8" :	3,000 PSI
Tamaño de 1/2" :	2,000 PSI

EXCEPCIONES

Tamaño 3/8" y más chica :	Tamaño 1/2"
101-B-2,500 PSI	102-B-1,000 PSI
102-B-2,500 PSI	104-B- 625 PSI
104-B-1,500 PSI	108-B-1,500 PSI
	116-B-1,500 PSI
	122-B-1,500 PSI

Rosca para tubo NPTF

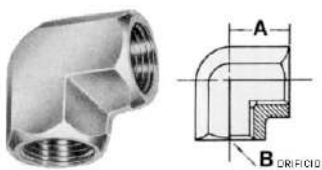
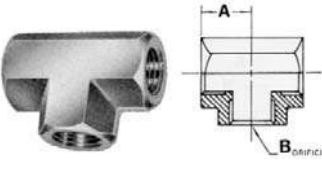
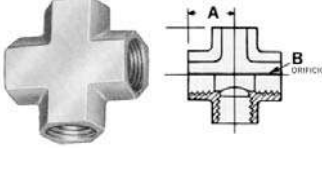
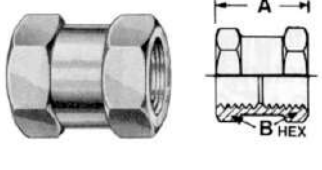
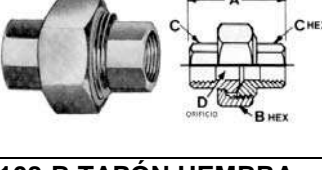
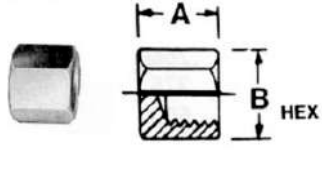
	Número de catálogo	Rosca Tubo NPTF	A	B	C	D	E	F	G
100-B CODO 90° HEMBRA 	100-B-02	1/8	0.546	0.328					
	100-B-04	1/4	0.781	0.422					
	100-B-06	3/8	0.812	0.562					
	100-B-08	1/2	1.015	0.687					
101-B TE UNIÓN 	101-B-02	1/8	0.546	0.328					
	101-B-04	1/4	0.719	0.422					
	101-B-06	3/8	0.840	0.562					
	101-B-08	1/2	1.230	0.687					
102-B CRUZ 	102-B-02	1/8	0.546	0.328					
	102-B-04	1/4	0.781	0.422					
	102-B-06	3/8	0.840	0.562					
	102-B-08	1/2	1.090	0.687					
103-B COPLE 	103-B-04	1/4	1.120	0.750					
	103-B-06	3/8	1.125	0.875					
104-B TUERCA UNIÓN 	104-B-04	1/4	1.468	1.062	0.687	0.437			
	104-B-06	3/8	1.625	1.312	0.875	0.562			
108-B TAPÓN HEMBRA 	108-B-02	1/8	0.500	0.563					
	108-B-04	1/4	0.750	0.750					
	108-B-06	3/8	0.875	0.875					
	108-B-08	1/2	1.063	1.063					

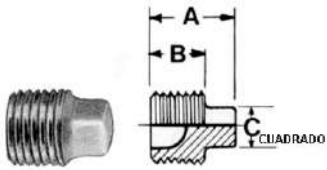
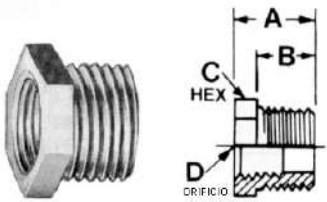
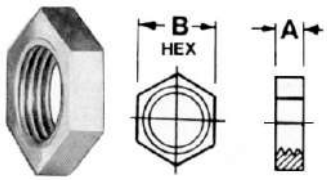
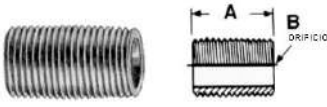
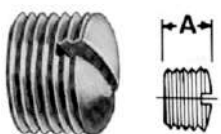

Rosca para tubo NPTF

	Número de catálogo	Rosca Tubo NPTF	A	B	C	D	E	F	G
109-B TAPÓN MACHO CABEZA CUADRADA 	109-B-02	1/8	0.609	0.340	0.281				
	109-B-04	1/4	0.813	0.500	0.375				
	109-B-06	3/8	0.844	0.500	0.438				
	109-B-08	1/2	1.078	0.678	0.563				
	Número de catálogo	Rosca Macho Tubo NPTF	Rosca Hembra Tubo NPTF	A	B	C	D	E	F
110-B REDUCCIÓN BUSHING 	110-B-0402	1/4	1/8	0.750	0.562	0.562	0.312		
	110-B-0602	3/8	1/8	0.750	0.562	0.688	0.328		
	110-B-0604	3/8	1/4	0.750	0.562	0.750	0.422		
	110-B-0802	1/2	1/8	1.000	0.750	0.875	0.328		
	110-B-0804	1/2	1/4	1.000	0.750	0.875	0.422		
	110-B-0806	1/2	3/8	1.000	0.750	0.875	0.562		
	110-B-1204	3/4	1/4	1.000	0.750	1.125	0.422		
	110-B-1206	3/4	3/8	1.000	0.750	1.125	0.562		
	110-B-1208	3/4	1/2	1.000	0.750	1.125	0.687		
	Número de catálogo	Rosca Recta Tubo NPSL	A	B	C	D	E	F	G
111-B CONTRA TUERCA 	111-B-02	1/8	0.187	0.625					
	111-B-04	1/4	0.250	0.687					
	111-B-06	3/8	0.250	0.937					
	111-B-08	1/2	0.250	1.125					
	Número de catálogo	Rosca Tubo NPTF	A	B	C	D	E	F	G
112-B NIPLE CORTO 	112-B-02	1/8	0.750	0.265					
	112-B-04	1/4	1.125	0.358					
	112-B-06	3/8	1.125	0.422					
	112-B-08	1/2	1.500	0.531					
	112-B-12	3/4	1.310	0.750					
	Número de catálogo	Rosca Tubo NPTF	A	B	C	D	E	F	G
117-B TAPÓN MACHO CABEZA RANURADA 	117-B-02	1/8	0.312						
	117-B-04	1/4	0.469						

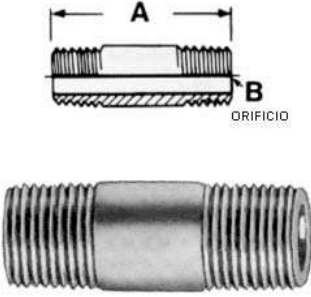
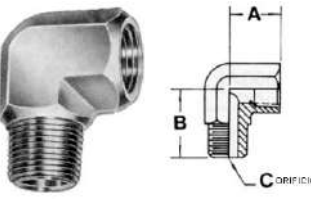
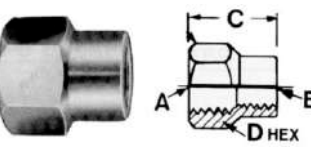
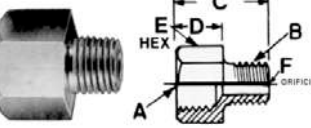
Rosca para tubo NPTF

	Número de catálogo	Rosca Tubo NPTF	A	B	C	D	E	F	G
113-B NIPLE LARGO									
	113-B-0224	1/8	1.500	0.265					
	113-B-0424	1/4	1.500	0.358					
	113-B-0624	3/8	1.500	0.500					
	113-B-0824	1/2	1.500	0.625					
	113-B-0232	1/8	2.000	0.265					
	113-B-0432	1/4	2.000	0.375					
	113-B-0632	3/8	2.000	0.500					
	113-B-0832	1/2	2.000	0.625					
	113-B-0240	1/8	2.500	0.281					
	113-B-0440	1/4	2.500	0.375					
	113-B-0640	3/8	2.500	0.500					
	113-B-0840	1/2	2.500	0.625					
	113-B-0248	1/8	3.000	0.281					
	113-B-0448	1/4	3.000	0.375					
	113-B-0648	3/8	3.000	0.500					
	113-B-0848	1/2	3.000	0.625					
	113-B-0850	1/2	3.125	0.625					
113-B-0256	1/8	3.500	0.281						
113-B-0456	1/4	3.500	0.375						
113-B-0656	3/8	3.500	0.500						
113-B-0856	1/2	3.500	0.625						
116-B CODO 90° TERMINAL MACHO									
	116-B-02	1/8	0.546	0.812	0.218				
	116-B-04	1/4	0.718	1.031	0.312				
	116-B-06	3/8	0.781	1.187	0.437				
	116-B-08	1/2	1.171	1.437	0.562				
	Número de catálogo	A Rosca Tubo NPTF	B Rosca Tubo NPTF	C	D	E	F		
119-B REDUCCIÓN HEMBRA									
	119-B-0402	1/4	1/8	0.970	0.750				
	119-B-0604	3/8	1/4	1.106	0.875				
	119-B-0804	1/2	1/4	1.093	1.062				
	119-B-0806	1/2	3/8	1.375	1.062				
	119-B-1208	3/4	1/2						
120-B ADAPTADOR									
	120-B-0202	1/8	1/8	0.906	0.531	0.500	0.191		
	120-B-0402	1/4	1/8	1.063	0.688	0.750	0.219		
	120-B-0404	1/4	1/4	1.250	0.688	0.750	0.312		
	120-B-0602	3/8	1/8	1.125	0.750	0.875			
	120-B-0604	3/8	1/4	1.250	0.688	0.875	0.312		
	120-B-0606	3/8	3/8	1.250	0.688	0.875			
	120-B-0806	1/2	3/8	1.469	0.906	1.062	0.406		
120-B-0808	1/2	1/2	1.660	0.910	1.062				

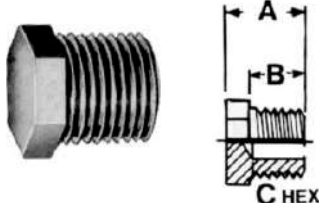
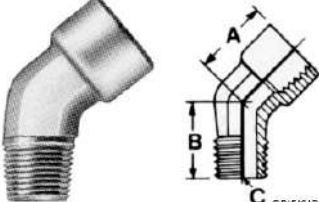
Rosca para tubo NPTF

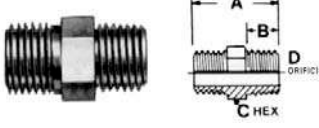
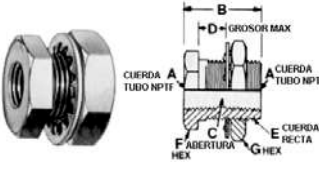
	Número de catálogo	Rosca Tubo NPTF	A	B	C	D	E	F	G
121-B TAPÓN MACHO CABEZA HEXAGONAL 	121-B-02	1/8	0.531	0.375	0.437				
	121-B-04	1/4	0.750	0.562	0.562				
	121-B-06	3/8	0.781	0.562	0.687				
	121-B-08	1/2	0.969	0.750	0.875				
	121-B-12	3/4	1.062	0.750	1.062				
124-B CODO 45° TERMINAL MACHO 	124-B-02	1/8	0.750	0.687	0.218				
	124-B-04	1/4	0.875	0.781	0.312				
	124-B-06	3/8	1.000	0.875	0.406				
	124-B-08	1/2	1.125	1.218	0.500				
127-B TE TERMINAL A UN LADO 	127-B-02	1/8	0.750	0.750	0.187				
	127-B-04	1/4	0.781	1.156	0.312				
	127-B-06	3/8	0.840	1.120	0.409				
	127-B-08	1/2	1.120	1.400	0.562				
	Número de catálogo	Rosca Tubo NPTF	Rosca Tubo NPTF	A	B	C	D	E	F
122-B NIPLE HEXAGONAL 	122-B-0202	1/8	1/8	0.960	0.375	0.437	0.187		
	122-B-0404	1/4	1/4	1.375	0.562	0.562	0.312		
	122-B-0402	1/4	1/8	1.000	0.437	0.562	0.218		
	122-B-0606	3/8	3/8	1.406	0.562	0.687	0.437		
	122-B-0604	3/8	1/4	1.187	0.500	0.687	0.343		
	122-B-0808	1/2	1/2	1.812	0.750	0.875	0.562		
	122-B-0804	1/2	1/4	1.625	0.750	0.875	0.281		
	122-B-0806	1/2	3/8	1.620	0.750	0.875	0.406		
	Número de catálogo	A Rosca Tubo NPTF	B Longitud	C	D	E	F	G	
129-B COPLE PARA MAMPARA 	129-B-0224	1/8	1 1/2	0.328	0.875	5/16- 18	0.875	0.937	
	129-B-0415	1/4	15/16	0.421	0.250	3/4- 16	1.000	1.125	
	129-B-0424	1/4	1 1/2	0.421	0.812	3/4- 16	1.000	1.125	
	129-B-0621	3/8	1 5/16	0.562	0.500	1- 14	1.125	1.437	
	129-B-0824	1/2	1 1/2	0.687	0.625	1 1/8- 14	1.250	1.500	

Compresión

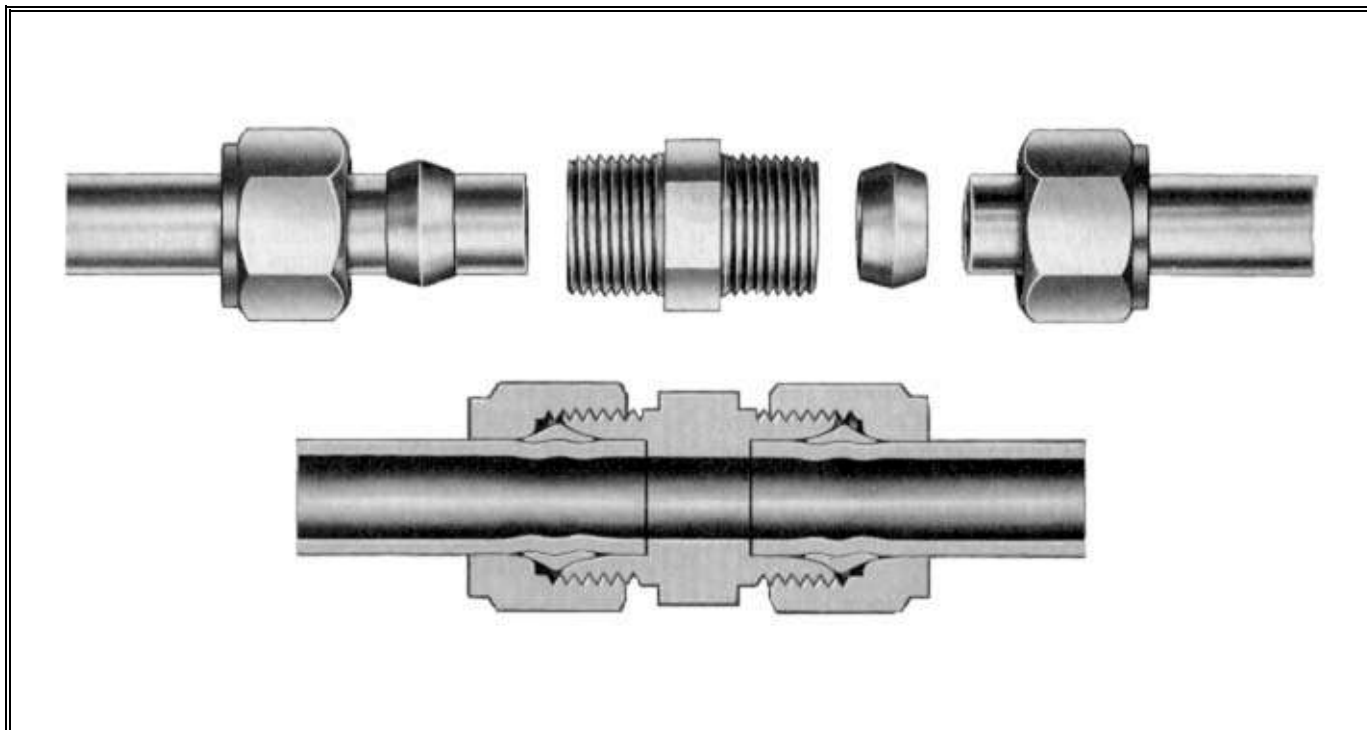

Conexión para uso general simple, eficiente y de bajo costo

TAMAÑO :

Tubo : de 1/8" a 3/4" de
diámetro exterior.
Terminales de 1/8" a 3/4"
NPTF

**PRESIÓN MÁXIMA DE
OPERACIÓN :**

400 PSI (28 kg/cm²)

MATERIALES :

Codos y Tes :
Latón forjado :
SAE CA377
Conectores, uniones, y
tuercas : Barra de latón :
SAE CA 360

COMPATIBILIDAD :

Tubo de Cobre, Aluminio, Latón y Acero suave sin
costura.

ESPECIFICACIONES :

S. A. E. : Cumple S. A. E. J512 Norma de tubo y
conexiones automotrices

A. N. S. I. y A. S. M. E :Código para tubería de
presión

Ver información específica en las siguientes hojas

Compresión



ESTÁNDAR INDUSTRIAL

La conexión tipo compresión es de las más populares por su eficiencia, bajo costo y facilidad para instalar. Diseñada en 1907, desde entonces ha sido una de las conexiones básicas para unir tubos en una gran variedad de aplicaciones.

FÁCIL DE INSTALAR

Para instalar estas conexiones no hace falta abocinarlas, soldarlas ni ninguna otra preparación especial. Simplemente se desliza la tuerca y el barril sobre el tubo, asegurándose antes haber cortado perfectamente a escuadra y haber limpiado las rebabas. Se inserta el tubo en el cuerpo de la conexión hasta que topa con el hombro. Se mueve el barril hasta que llegue a la posición correcta y se aprieta la tuerca.

CUERPOS FORJADOS EN CODOS Y TES

Los cuerpos de los codos y las tes son piezas forjadas de latón. La extraordinaria resistencia de las conexiones forjadas (superior al 80% respecto a las conexiones de fundición) da un margen de seguridad adicional. Esta resistencia superior hace que las conexiones forjadas resistan mejor los golpes, la vibración y el esfuerzo mecánico. La estructura de grano sumamente fino de las piezas forjadas garantiza que no tenga poros o defectos ocultos, así como contra fuga de líquidos y gases de difícil contención. Las caras planas para las llaves de tuercas y la mayor uniformidad de las piezas forjadas facilita su manejo rápido y seguro con la llave y acelera el trabajo de instalación.

APLICACIONES.

Esta conexión es extensamente usada para conectar líneas de aire, vacío agua, aceite, grasa y gasolina, así como para otras conexiones en tubería

de mediana y baja presión que no están sujetas a una excesiva vibración o movimiento de los tubos.

ROSCAS PARA TUBOS

Rosca cónica para tubo Drysel American Standard.

INFORMACIÓN PARA PEDIDO

Para hacer un pedido, simplemente indique el número de catálogo para la configuración y las medidas deseadas.

EJEMPLO :

3/8" (6/16") diámetro exterior x rosca macho para tubo de 1/4" (4/16")
68-F-0604

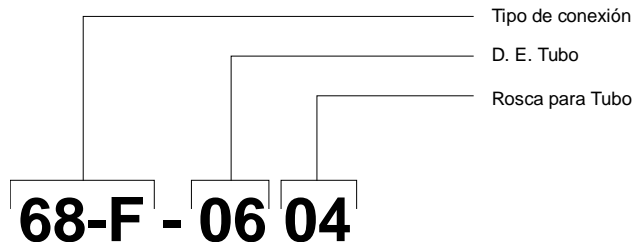

Compresión

PRESIONES MÁXIMAS DE OPERACIÓN RECOMENDADAS (PSI)

MATERIAL DE LAS CONEXIONES :
LATÓN

MATERIAL DE LA TUBERÍA :
COBRE BLANDO Y COBRE MEDIO DURO

CONDICIONES DE SERVICIO	DIAM. EXT.	TIPO DE TUBERÍA Y GROSOR DE PARED									
		COBRE BLANDO (SIN COSTURA)					COBRE MEDIO DURO (SIN COSTURA)				
		.030"	.032"	.035"	.049"	.065"	.032"	.035"	.042"	.049"	.065"
Presión estática	1/8"	400	400	400			400				
	3/16"	400	400	400			400				
Vibración mínima de la línea	1/4"	300	300	300			300				
	5/16"		300	300			300				
	3/8"			200			200	200			
	1/2"			200		200	200	200			200
	5/8"			150	150	150	150			150	150
	3/4"				100	100			100		100

Estas conexiones no son recomendadas en donde puedan estar presentes vibración y aumentos de presión hidráulica severos

DIMENSIONES

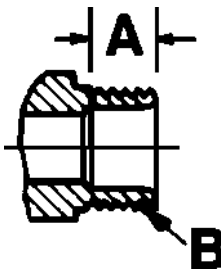
	Diámetro Exterior del tubo	A	B
		1/8"	0.188
	5/32"	0.188	5/16-24
	3/16"	0.219	3/8-24
	1/4"	0.250	7/16-24
	5/16"	0.281	1/2-24
	3/8"	0.313	9/16-24
	7/16"	0.344	5/8-24
	1/2"	0.375	11/16-20
	5/8"	0.375	13/16-18
	3/4"	0.438	1-18

Compresión

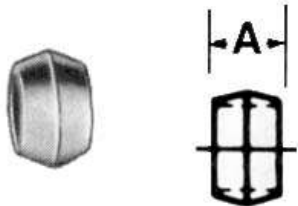
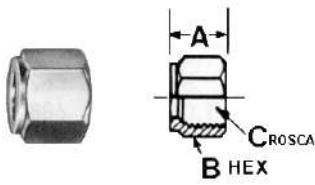
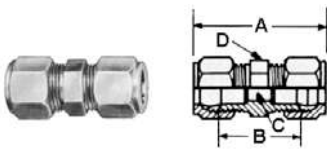
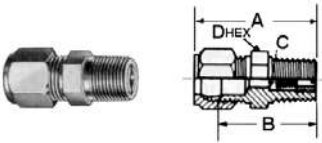
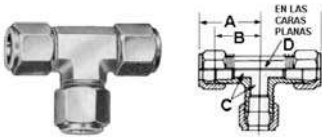
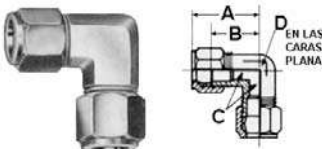
	Número de catálogo	D. E. Tubo	Rosca Tubo NPTF	A	B	C	D	E	F
60-F BARRIL									
	60-F-02	1/8		0.188					
	60-F-03	3/16		0.219					
	60-F-04	1/4		0.250					
	60-F-05	5/16		0.250					
	60-F-06	3/8		0.250					
	60-F-08	1/2		0.375					
	60-F-10	5/8		0.438					
	60-F-12	3/4		0.500					
61-F TUERCA									
	61-F-02	1/8		0.375	0.375	5/16-24			
	61-F-03	3/16		0.406	0.438	3/8-24			
	61-F-04	1/4		0.438	0.500	7/16-24			
	61-F-05	5/16		0.438	0.562	1/2-24			
	61-F-06	3/8		0.469	0.625	9/16-24			
	61-F-08	1/2		0.625	0.812	11/16-20			
	61-F-10	5/8		0.740	0.938	13/16-18			
	61-F-12	3/4		0.810	1.125	1-18			
62-F UNIÓN									
	62-F-02	1/8		1.125	0.656	0.093	0.312		
	62-F-03	3/16		1.250	0.750	0.125	0.375		
	62-F-04	1/4		1.438	0.812	0.188	0.438		
	62-F-05	5/16		1.469	0.875	0.250	0.500		
	62-F-06	3/8		1.578	0.984	0.312	0.562		
	62-F-08	1/2		1.938	1.093	0.406	0.688		
	62-F-10	5/8		2.359	1.450	0.531	0.812		
	62-F-12	3/4		2.562	1.620	0.656	1.000		
63-F CONECTOR CHECK TERMINAL MACHO									
	63-F-0202	1/8	1/8	1.015	0.781	0.093	0.438		
	63-F-0302	3/16	1/8	1.093	0.844	0.136	0.438		
	63-F-0402	1/4	1/8	1.188	0.875	0.136	0.438		
	63-F-0502	5/16	1/8	1.203	0.906	0.136	0.500		
64-F TE UNIÓN									
	64-F-02	1/8		0.859	0.625	0.093	0.312		
	64-F-03	3/16		0.875	0.625	0.125	0.312		
	64-F-04	1/4		0.938	0.625	0.188	0.438		
	64-F-05	5/16		0.984	0.688	0.250	0.438		
	64-F-06	3/8		1.078	0.781	0.312	0.500		
	64-F-08	1/2		1.359	0.938	0.406	0.625		
	64-F-10	5/8		1.594	1.130	0.531	0.812		
	64-F-12	3/4		1.781	1.312	0.656	1.000		
65-F-CODO 90° UNIÓN									
	64-F-02	1/8		0.859	0.625	0.093	0.312		
	64-F-03	3/16		0.875	0.625	0.125	0.375		
	64-F-04	1/4		0.938	0.625	0.188	0.375		
	64-F-05	5/16		0.984	0.688	0.250	0.438		
	64-F-06	3/8		1.078	0.781	0.312	0.500		
	64-F-08	1/2		1.359	0.938	0.406	0.625		
	64-F-10	5/8		1.547	1.093	0.531	0.812		

Compresión

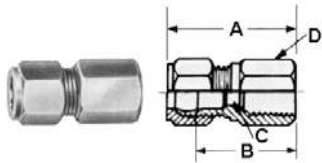
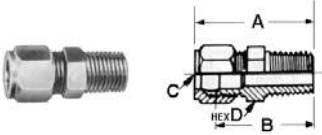
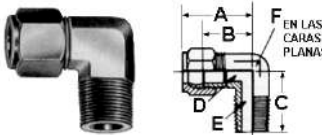
	Número de catálogo	D. E. Tubo	Rosca Tubo NPTF	A	B	C	D	E	F
66-F CONECTOR HEMBRA 	66-F-0202	1/8	1/8	0.984	0.750	0.093	0.562		
	66-F-0302	3/16	1/8	1.031	0.781	0.125	0.562		
	66-F-0402	1/4	1/8	1.093	0.781	0.188	0.562		
	66-F-0404	1/4	1/4	1.344	1.031	0.188	0.688		
	66-F-0502	5/16	1/8	1.109	0.812	0.250	0.562		
	66-F-0504	5/16	1/4	1.328	1.031	0.250	0.688		
	66-F-0602	3/8	1/8	1.141	0.844	0.250	0.562		
	66-F-0604	3/8	1/4	1.359	1.062	0.312	0.688		
	66-F-0606	3/8	3/8	1.637	1.340		0.812		
	66-F-0806	1/2	3/8	1.547	1.125	0.406	0.875		
	66-F-0808	1/2	1/2	1.766	1.344	0.406	1.000		
	66-F-1008	5/8	1/2	1.969	1.510	0.531	1.062		
	66-F-1208	3/4	1/2	2.062	1.580	0.656	1.062		
	68-F CONECTOR MACHO 	68-F-0202	1/8	1/8	1.031	0.797	0.093	0.438	
68-F-0302		3/16	1/8	1.109	0.859	0.125	0.438		
68-F-0402		1/4	1/8	1.187	0.875	0.188	0.438		
68-F-0404		1/4	1/4	1.375	1.062	0.188	0.562		
68-F-0502		5/16	1/8	1.203	0.906	0.250	0.500		
68-F-0504		5/16	1/4	1.391	1.093	0.250	0.562		
68-F-0602		3/8	1/8	1.266	0.969	0.250	0.562		
68-F-0604		3/8	1/4	1.453	1.156	0.312	0.562		
68-F-0606		3/8	3/8	1.453	1.156	0.312	0.688		
68-F-0608		3/8	1/2	1.672	1.375	0.312	0.875		
68-F-0804		1/2	1/4	1.641	1.219	0.312	0.687		
68-F-0806		1/2	3/8	1.641	1.219	0.406	0.688		
68-F-0808		1/2	1/2	1.859	1.438	0.406	0.875		
68-F-0812		1/2	3/4	1.922	1.500	0.406	1.125		
68-F-1006		5/8	3/8	1.764	1.312	0.531	0.812		
68-F-1008		5/8	1/2	2.062	1.610	0.531	0.875		
68-F-1012		5/8	3/4	2.093	1.640	0.531	1.125		
68-F-1208		3/4	1/2	2.188	1.710	0.531	1.000		
68-F-1212	3/4	3/4	2.188	1.710	0.656	1.125			
69-F CODO 90° TERMINAL MACHO 	69-F-0202	1/8	1/8	0.859	0.625	0.688	0.093	0.219	0.312
	69-F-0302	3/16	1/8	0.875	0.625	0.688	0.125	0.219	0.438
	69-F-0304	3/16	1/4	0.875	0.625	0.937	0.125	0.281	0.437
	69-F-0402	1/4	1/8	0.969	0.656	0.750	0.188	0.219	0.375
	69-F-0404	1/4	1/4	1.031	0.719	0.938	0.188	0.281	0.438
	69-F-0502	5/16	1/8	0.922	0.625	0.750	0.250	0.234	0.438
	69-F-0504	5/16	1/4	1.046	0.750	0.938	0.250	0.281	0.438
	69-F-0602	3/8	1/8	1.046	0.750	0.844	0.312	0.219	0.500
	69-F-0604	3/8	1/4	1.078	0.781	0.938	0.312	0.344	0.500
	69-F-0606	3/8	3/8	1.172	0.875	1.000	0.312	0.344	0.562
	69-F-0608	3/8	1/2	1.234	0.938	1.250	0.312	0.500	0.688
	69-F-0804	1/2	1/4	1.359	0.938	1.062	0.406	0.344	0.625
	69-F-0806	1/2	3/8	1.359	0.938	1.125	0.406	0.406	0.625
	69-F-0808	1/2	1/2	1.422	1.000	1.250	0.406	0.500	0.688
	69-F-0812	1/2	3/4	1.547	1.125	1.250	0.406	0.750	0.875
	69-F-1006	5/8	3/8	1.594	1.130	1.125	0.500	0.406	0.812
	69-F-1008	5/8	1/2	1.594	1.130	1.280	0.531	0.531	0.812
	69-F-1012	5/8	3/4	1.719	1.260	1.500	0.531	0.656	0.938
69-F-1208	3/4	1/2	1.745	1.281	1.500	0.656	0.531	0.875	
69-F-1212	3/4	3/4	1.776	1.312	1.500	0.656	0.656	0.875	

Compresión

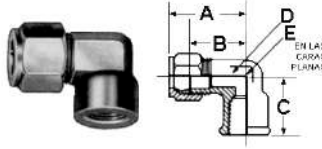
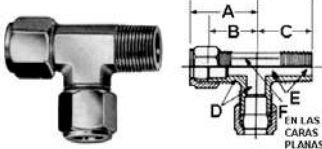
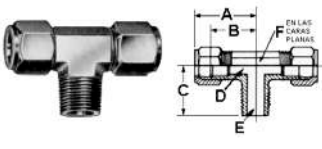
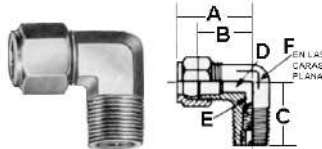
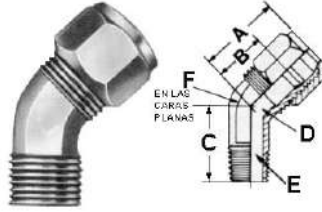
	Número de catálogo	D. E. Tubo	Rosca Tubo NPTF	A	B	C	D	E	F
70-F CODO 90° TERMINAL HEMBRA 	70-F-0202	1/8	1/8	0.922	0.688	0.547	0.093	0.562	
	70-F-0302	3/16	1/8	0.969	0.719	0.547	0.125	0.562	
	70-F-0402	1/4	1/8	1.062	0.750	0.547	0.188	0.562	
	70-F-0404	1/4	1/4	1.188	0.875	0.719	0.188	0.688	
	70-F-0502	5/16	1/8	0.984	0.688	0.688	0.250	0.438	
	70-F-0604	3/8	1/4	1.141	0.844	0.875	0.312	0.500	
	70-F-0806	1/2	3/8	1.453	1.031	0.906	0.406	0.625	
	70-F-0808	1/2	1/2	1.547	1.125	1.188	0.406	0.688	
	70-F-1008	5/8	1/2	1.828	1.375	1.172	0.531	1.188	
	71-F TE TERMINAL A UN LADO 	71-F-0202	1/8	1/8	0.859	0.625	0.688	0.093	0.188
71-F-0402		1/4	1/8	1.000	0.688	0.750	0.188	0.188	0.375
71-F-0502		5/16	1/8	0.953	0.656	0.750	0.250	0.219	0.438
71-F-0604		3/8	1/4	1.078	0.781	0.938	0.312	0.312	0.500
71-F-0806		1/2	3/8	1.359	0.938	1.093	0.406	0.406	0.625
71-F-1008		5/8	1/2	1.562	1.100	1.280	0.531	0.531	0.812
72-F TE TERMINAL AL CENTRO 		72-F-0202	1/8	1/8	0.859	0.625	0.688	0.093	0.188
	72-F-0302	3/16	1/8	0.875	0.625	0.688	0.125	0.188	0.312
	72-F-0402	1/4	1/8	1.000	0.688	0.750	0.188	0.219	0.375
	72-F-0404	1/4	1/4	1.031	0.719	0.938	0.188	0.312	0.500
	72-F-0502	5/16	1/8	0.953	0.656	0.750	0.250	0.234	0.438
	72-F-0504	5/16	1/4	1.047	0.750	0.840	0.250	0.312	0.625
	72-F-0604	3/8	1/4	1.078	0.781	0.938	0.312	0.312	0.500
	72-F-0806	1/2	3/8	1.359	0.938	1.093	0.406	0.406	0.625
	72-F-1008	5/8	1/2	1.577	1.156	1.343	0.531	0.531	0.625
73-F CODO 90° CHECK TERMINAL MACHO 	73-F-0202	1/8	1/8	0.859	0.625	0.688	0.093	0.136	0.375
	73-F-0402	1/4	1/8	0.969	0.656	0.750	0.188	0.136	0.375
74-F CODO 45° TERMINAL MACHO 	74-F-0402	1/4	1/8	1.081	0.660	0.560			0.593
	74-F-0602	3/8	1/8						
	74-F-0604	3/8	1/4	1.041	0.620	0.840	0.312	0.312	0.500
	74-F-0606	3/8	3/8	1.111	0.690	0.880	0.312	0.312	0.500
	74-F-0806	1/2	3/8	1.109	0.688	0.875	0.406	0.406	0.625

Compresión

	Número de catálogo	D. E. Tubo	Rosca Tubo NPTF	A	B	C	D	E	F	G
76-F TE TERMINAL HEMBRA, MACHO COMPRESIÓN	76-F-0402	1/4	1/8	1.093	0.781	0.531	0.719	0.188	0.219	0.562
	76-F-0502	5/16	1/8	1.078	0.781	0.594	0.719	0.219	0.219	0.562
	76-F-0604	3/8	1/4	1.234	0.938	0.750	0.844	0.312	0.312	0.750

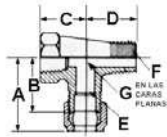

Frenos de aire. Tubo de cobre

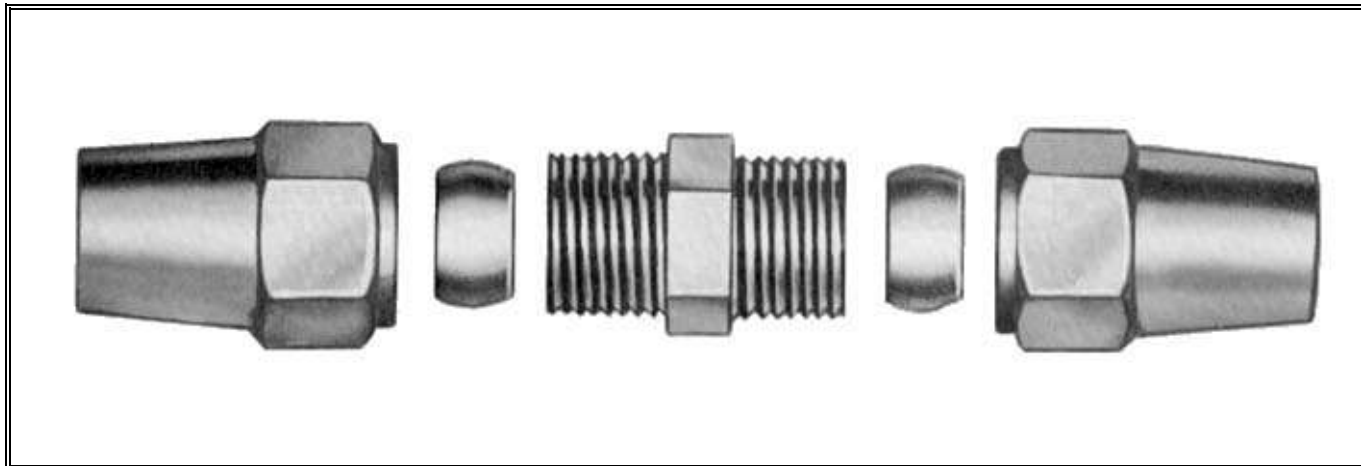

Conexiones de compresión de tuerca larga, diseñadas para lograr la mayor confiabilidad en las líneas de frenos de aire automotrices

Una conexión a compresión de tres piezas fabricada de acuerdo con normas SAE.

TAMAÑO : Tubo : de 1/4" a 3/4" de diámetro exterior.
Terminales de 1/4" a 3/4" NPTF

PRESIÓN MÁXIMA DE OPERACIÓN : 400 PSI (28 kg/cm²)

MATERIALES : Codos y Tes :
Latón forjado :
SAE CA 377
Conectores, uniones, y tuercas : Barra de latón :
SAE CA 360

COMPATIBILIDAD : Tubería de Nylon para frenos de aire, Cobre, Aluminio, Latón y Acero suave sin costura.

ESPECIFICACIONES :

S. A. E. : Cumple S. A. E. J246 Norma para conexiones de frenos de aire y FMVSS-106.

ROSCAS PARA TUBOS

Rosca cónica para tubo Drysel American Standard.

INFORMACIÓN PARA PEDIDO

Para hacer un pedido, simplemente indique el número de catálogo para la configuración y las medidas deseadas.

EJEMPLO :

3/8" (6/16") diámetro exterior x rosca macho para tubo de 1/4" (4/16")
468-F-0604

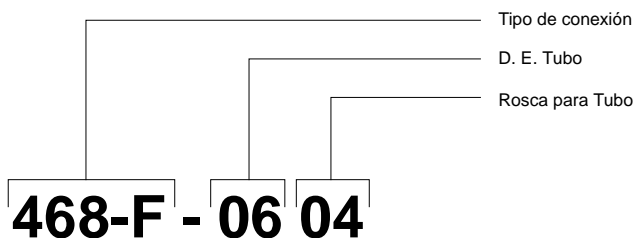

Frenos de aire. Tubo de cobre

DIMENSIONES

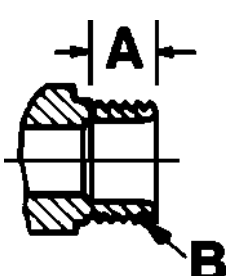
	Diámetro Exterior del tubo	A	B rosca
	1/4"	0.250	7/16-24
3/8"	0.310	17/32-24	
1/2"	0.440	11/16-20	
5/8"	0.440	13/16-18	
3/4"	0.560	1-18	

SELLO DOT

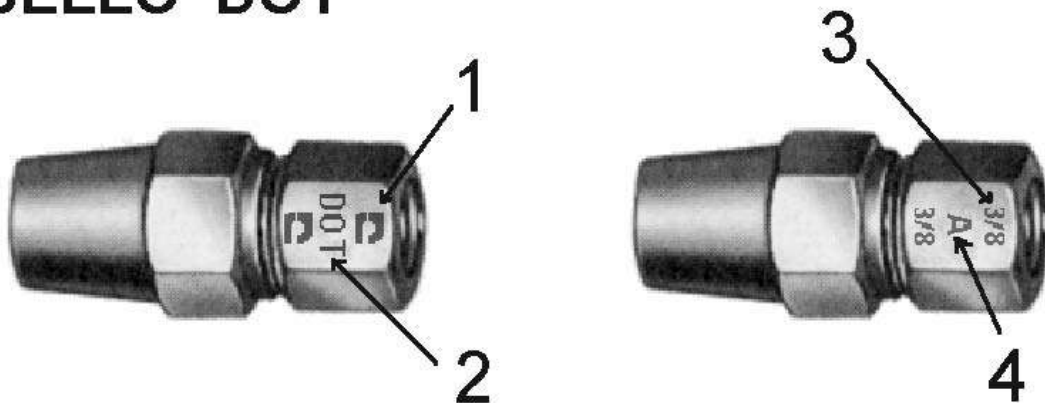

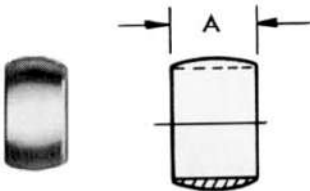
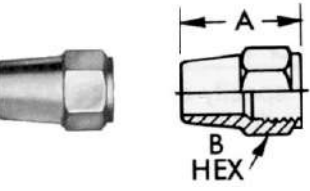
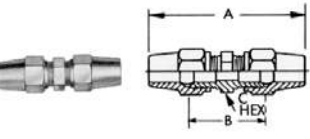
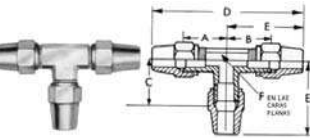
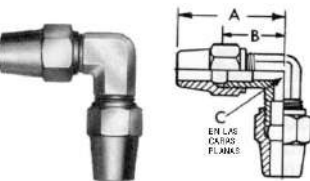
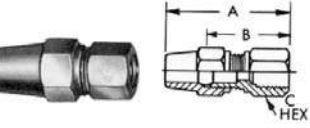

1. Logotipo de Nacobre, Identificación del Fabricante de Conexiones
2. El símbolo DOT es una certificación al fabricante de conexión final de acuerdo con la norma FMVSS-106
3. Diámetro exterior del tubo en fracción de pulgada con lo que la conexión es sellada
4. La letra A indica que la conexión es destinada para su uso en sistemas de frenos de aire.

Frenos de aire. Tubo de cobre

	Número de catálogo	D. E. Tubo	Rosca Tubo NPTF	A	B	C	D	E	F
460-F BARRIL 	460-F-04	1/4		0.250					
	460-F-06	3/8		0.313					
	460-F-08	1/2		0.375					
	460-F-10	5/8		0.438					
	460-F-12	1/2		0.500					
461-F TUERCA 	461-F-04	1/4		0.750	0.562				
	461-F-05	5/16		0.812	0.625				
	461-F-06	3/8		1.130	0.625				
	461-F-08	1/2		1.250	0.812				
	461-F-10	5/8		1.380	0.937				
	461-F-12	3/4		1.560	1.125				
462-F UNIÓN 	462-F-04	1/4		2.050	0.870	0.437			
	462-F-06	3/8		2.940	1.120	0.562			
	462-F-08	1/2		3.210	1.330	0.687			
	462-F-10	5/8		3.570	1.450	0.812			
	462-F-12	3/4		4.120	1.620	1.000			
464-F TE UNIÓN 	464-F-04	1/4		0.630	0.630	0.630	2.440	1.220	0.437
	464-F-06	3/8		0.830	0.830	0.830	3.480	1.740	0.500
	464-F-08	1/2		0.970	0.970	0.970	3.820	1.910	0.625
	464-F-10	5/8		1.130	1.130	1.130	1.380	2.190	0.812
	464-F-12	3/4							
465-F CODO 90° UNIÓN 	465-F-04	1/4		1.250	0.660	0.375			
	465-F-06	3/8		1.710	0.800	0.500			
	465-F-08	1/2		1.910	0.970	0.625			
	465-F-10	5/8		2.190	1.130	0.750			
466-F-CONECTOR HEMBRA 	466-F-0402	1/4	1/8	1.164	0.812	0.562			
	466-F-0404	1/4	1/4	1.414	1.062	0.750			
	466-F-0602	3/8	1/8	1.195	0.843	0.562			
	466-F-0604	3/8	1/4	1.508	1.156	0.750			
	466-F-0606	3/8	3/8	1.508	1.156	0.875			
	466-F-0806	1/2	3/8	1.602	1.250	0.875			
	466-F-0808	1/2	1/2	1.852	1.500	1.062			
	466-F-1008	5/8	1/2	1.852	1.500	1.062			
	466-F-1208	3/4	1/2	1.852	1.500	1.062			

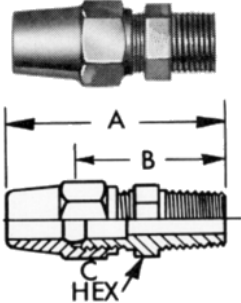
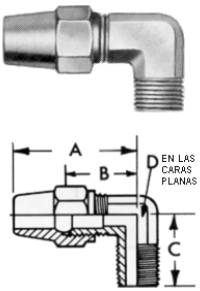
Frenos de aire. Tubo de cobre

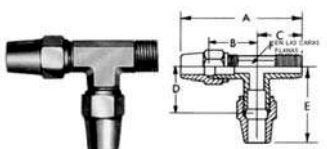
	Número de catálogo	D. E. Tubo	Rosca Tubo NPTF	A	B	C	D	E	F
468-F CONECTOR MACHO 	468-F-0402	1/4	1/8	1.210	0.920	0.437			
	468-F-0404	1/4	1/4	1.420	1.130	0.562			
	468-F-0406	1/4	3/8	1.492	1.140	0.687			
	468-F-0602	3/8	1/8	1.370	1.030	0.562			
	468-F-0604	3/8	1/4	1.580	1.240	0.562			
	468-F-0606	3/8	3/8	1.580	1.240	0.687			
	468-F-0608	3/8	1/2	1.800	1.460	0.875			
	468-F-0804	1/2	1/4	1.710	1.360	0.687			
	468-F-0806	1/2	3/8	1.710	1.360	0.687			
	468-F-0808	1/2	1/2	1.900	1.550	0.875			
	468-F-0812	1/2	3/4	1.930	1.580	1.125			
	468-F-1006	5/8	3/8	1.840	1.420	0.812			
	468-F-1008	5/8	1/2	2.030	1.610	0.875			
	468-F-1012	5/8	3/4	2.013	1.593	1.125			
	468-F-1208	3/4	1/2	2.156	1.656	1.000			
468-F-1212	3/4	3/4	2.220	1.720	1.062				
469-F CODO 90° TERMINAL MACHO 	469-F-0402	1/4	1/8	0.920	0.630	0.670	0.375		
	469-F-0404	1/4	1/4	1.040	0.750	0.930	0.437		
	469-F-0406	1/4	3/8	1.008	0.718	1.062	0.750		
	469-F-0602	3/8	1/8	1.170	0.830	0.880	0.500		
	469-F-0604	3/8	1/4	1.170	0.830	0.960	0.500		
	469-F-0606	3/8	3/8	1.280	0.940	1.100	0.687		
	469-F-0608	3/8	1/2	1.340	1.000	1.280	0.750		
	469-F-0804	1/2	1/4	1.320	0.970	1.100	0.625		
	469-F-0806	1/2	3/8	1.290	0.940	1.100	0.687		
	469-F-0808	1/2	1/2	1.420	1.070	1.250	0.750		
	469-F-0812	1/2	3/4	1.510	1.160	1.500	0.937		
	469-F-1006	5/8	3/8	1.550	1.130	1.130	0.812		
	469-F-1008	5/8	1/2	1.550	1.130	1.280	0.812		
	469-F-1012	5/8	3/4	1.680	1.260	1.500	0.937		
	469-F-1208	3/4	1/2	1.700	1.200	1.340	0.875		
469-F-1212	3/4	3/4	1.830	1.330	1.500	0.937			
470-F CODO 90° TERMINAL HEMBRA 	470-F-0402	1/4	1/8	1.320	0.730	0.570	0.562		
	470-F-0604	3/8	1/4	1.810	0.900	0.810	0.500		
	470-F-0806	1/2	3/8	1.980	1.040	0.860	0.625		
	470-F-0808	1/2	1/2	2.080	1.140	1.188	0.687		
	470-F-1008	5/8	1/2	2.290	1.230	1.080	1.187		
471-F TE MACHO AL CENTRO 	471-F-0402	1/4	1/8	1.620	0.630	0.700	0.630	1.220	0.437
	471-F-0604	3/8	1/4	2.100	0.830	0.930	0.830	1.740	0.500
	471-F-0806	1/2	3/8	3.420	0.970	1.100	0.910	1.910	0.750
	471-F-0808	1/2	1/2	3.918	1.125	1.125	1.125		0.812
	471-F-1008	5/8	1/2	2.800	1.100	1.280	1.125		0.812

Frenos de aire. Tubo de cobre

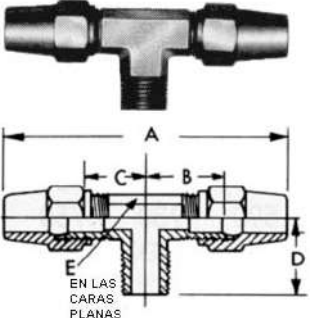
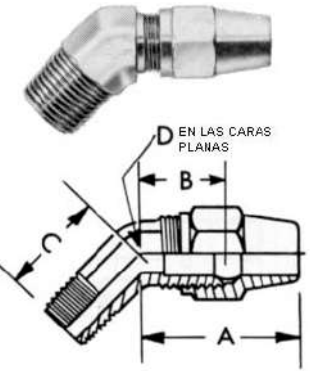
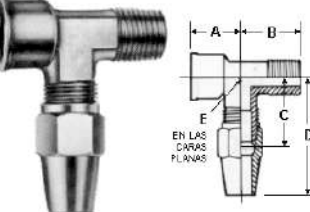
	Número de catálogo	D. E. Tubo	Rosca Tubo NPTF	A	B	C	D	E	F
472-F TE MACHO AL CENTRO 	472-F-0402	1/4	1/8	1.840	0.630	0.630	0.700	0.437	
	472-F-0404	1/4	1/4	2.180	0.720	0.720	0.960	0.500	
	472-F-0602	3/8	1/8	3.134	0.812	0.812	0.750	0.437	
	472-F-0604	3/8	1/4	2.340	0.830	0.830	0.930	0.500	
	472-F-0606	3/8	3/8	3.322	0.906	0.906	1.062	0.625	
	472-F-0806	1/2	3/8	2.640	0.970	0.970	1.100	0.750	
	472-F-0808	1/2	1/2	2.840	1.070	1.070	1.250	0.812	
	472-F-1008	5/8	1/2	3.040	1.100	1.100	1.280	0.812	
474-F CODO 45° MACHO 	474-F-0604	3/8	1/4	1.060	0.720	0.860	0.500		
	474-F-0606	3/8	3/8	1.030	0.690	0.910	0.625		
	474-F-0806	1/2	3/8	1.121	0.781	0.875	0.625		
476-F TE HEMBRA MACHO LATERAL 	476-F-0404	1/4	1/4	0.750	0.844	0.780	1.370	0.750	
	476-F-0604	3/8	1/4	0.750	1.130	0.930	1.840	0.750	

Frenos de aire. Tubo de Nylon



Conexiones especialmente diseñadas para usarse con tubo de Nylon SAE J 844 tipos 3A y 3B, para frenos de aire automotrices

Una conexión a compresión de tres piezas fabricada de acuerdo con normas SAE. Incluye inserto preensamblado.

TAMAÑO : Tubo : de 1/4" a 3/4" de diámetro exterior.
Terminales de 1/4" a 3/4" NPTF

PRESIÓN MÁXIMA DE OPERACIÓN : 350 PSI (25 kg/cm²) dependiendo del tubo utilizado

MATERIALES : Codos y Tes :
Latón forjado :
SAE CA377
Conectores, uniones, y tuercas : Barra de latón aliviada de esfuerzos :
SAE CA360 o similar

COMPATIBILIDAD : Tubería de Nylon SAE J 844 tipos 3A y 3B para frenos de aire.

ESPECIFICACIONES :

S. A. E. : Cumple S. A. E. J 246 Norma para conexiones de frenos de aire.

FMVSS (DOT) 106

ROSCAS PARA TUBOS

Rosca larga para tubo Drysel American Standard.

INFORMACIÓN PARA PEDIDO

Para hacer un pedido, simplemente indique el número de catálogo para la configuración y las medidas deseadas.

EJEMPLO :

3/8" (6/16") diámetro exterior x rosca macho para tubo de 1/4" (4/16")
4-468-F-0604

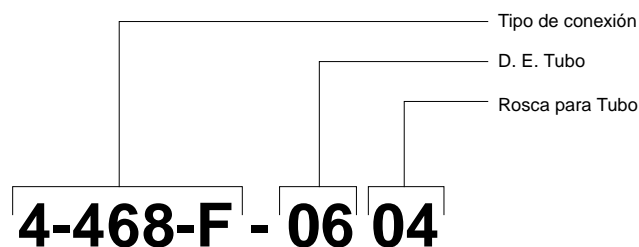

Frenos de aire. Tubo de Nylon

DIMENSIONES

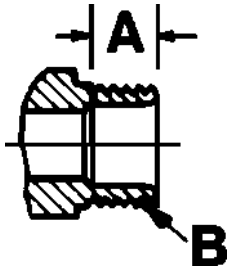
	Diámetro Exterior del tubo	A	B rosca
	1/4"	0.250	7/16-24
3/8"	0.310	17/32-24	
1/2"	0.440	11/16-20	
5/8"	0.440	13/16-18	
3/4"	0.560	1-18	
1"	0.780	1 1/4-16	

SELLO DOT

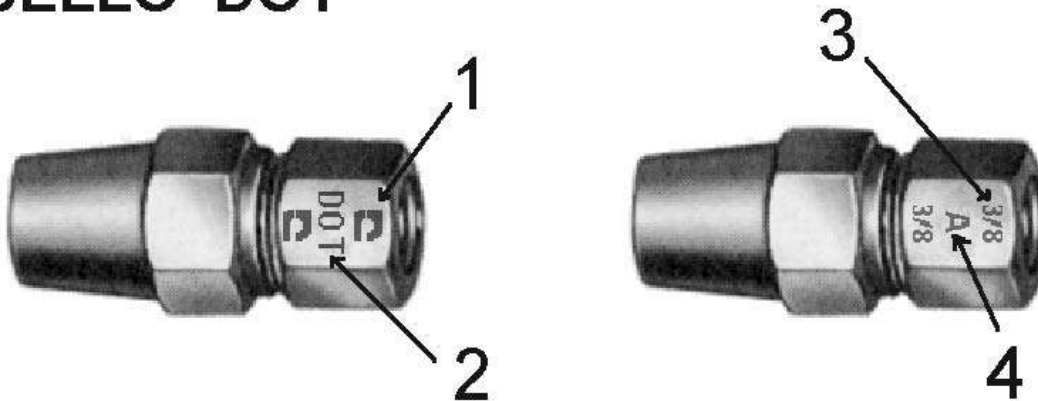





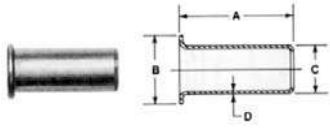
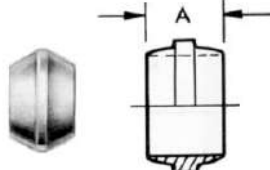
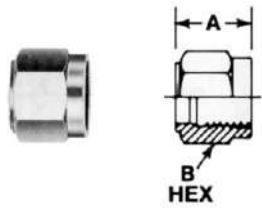
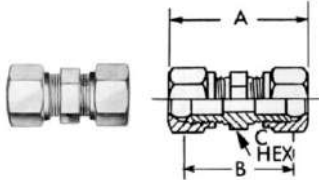
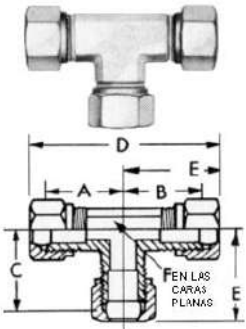

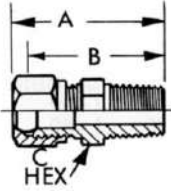

1. Logotipo de Nacobre, Identificación del Fabricante de Conexiones
2. El símbolo DOT es una certificación al fabricante de conexión final de acuerdo con la norma FMVSS-106
3. Diámetro exterior del tubo en fracción de pulgada con lo que la conexión es sellada
4. La letra A indica que la conexión es destinada para su uso en sistemas de frenos de aire.

Frenos de aire. Tubo de Nylon

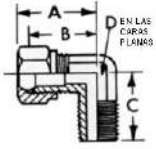
	Número de catálogo	D. E. Tubo	Rosca Tubo NPTF	A	B	C	D	E	F	
4-459-F INSERTO 	4-459-F-04	1/4		0.530	0.218	0.163	0.017			
	4-459-F-06	3/8		0.640	0.343	0.245	0.018			
	4-459-F-08	1/2		0.840	0.437	0.370	0.018			
	4-459-F-10	5/8		0.860	0.562	0.435	0.018			
4-460-F BARRIL 	4-460-F-04	1/4		0.310						
	4-460-F-06	3/8		0.390						
	4-460-F-08	1/2		0.430						
	4-460-F-10	5/8		0.446						
	4-460-F-12	3/4		0.540						
4-461-F TUERCA 	4-461-F-04	1/4		0.450	0.562					
	4-461-F-06	3/8		0.640	0.625					
	4-461-F-08	1/2		0.720	0.812					
	4-461-F-10	5/8		0.770	0.937					
4-462-F UNIÓN 	4-462-F-04	1/4		1.450	0.870	0.437				
	4-462-F-06	3/8		1.800	1.120	0.562				
	4-462-F-08	1/2		2.030	1.330	0.687				
	4-462-F-10	5/8		2.290	1.450	0.812				
4-464-F TE UNIÓN 	4-464-F-04	1/4		0.630	0.630	0.630	1.840	0.920	0.437	0.920
	4-464-F-06	3/8		0.830	0.830	0.830	2.340	1.170	0.500	1.170
	4-464-F-08	1/2		0.970	0.970	0.970	2.640	1.320	0.625	1.320

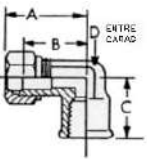
Frenos de aire. Tubo de Nylon

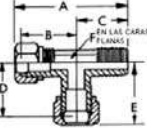
	Número de catálogo	D. E. Tubo	Rosca Tubo NPTF	A	B	C	D	E	F
4-466-F-CONECTOR HEMBRA 	4-466-F-0402	1/4	1/8	1.160	0.812	0.562			
	4-466-F-0404	1/4	1/4	1.410	1.062	0.750			
	4-466-F-0602	3/8	1/8	1.191	0.843	0.562			
	4-466-F-0604	3/8	1/4	1.504	1.156	0.750			
	4-466-F-0606	3/8	3/8	1.504	1.156	0.875			
	4-466-F-0808	1/2	1/2	1.850	1.500	1.062			
	4-466-F-1008	5/8	1/2	1.850	1.500	1.062			
4-468-F CONECTOR MACHO  	4-468-F-0402	1/4	1/8	1.210	0.920	0.437			
	4-468-F-0404	1/4	1/4	1.420	1.130	0.562			
	4-468-F-0406	1/4	3/8	1.480	1.140	0.687			
	4-468-F-0602	3/8	1/8	1.370	1.030	0.562			
	4-468-F-0604	3/8	1/4	1.580	1.240	0.562			
	4-468-F-0606	3/8	3/8	1.580	1.240	0.687			
	4-468-F-0804	1/2	1/4	1.710	1.360	0.687			
	4-468-F-0806	1/2	3/8	1.710	1.360	0.687			
	4-468-F-0808	1/2	1/2	1.900	1.550	0.875			
	4-468-F-1006	5/8	3/8	1.840	1.420	0.812			
	4-468-F-1008	5/8	1/2	2.030	1.610	0.875			
	4-468-F-1208	3/4	1/2	2.210	1.710	1.000			
4-469-F CODO 90° TERMINAL MACHO  	4-469-F-0402	1/4	1/8	0.920	0.630	0.670	0.375		
	4-469-F-0404	1/4	1/4	1.040	0.750	0.930	0.437		
	4-469-F-0406	1/4	3/8	1.058	0.718	1.062	0.750		
	4-469-F-0602	3/8	1/8	1.170	0.830	0.880	0.500		
	4-469-F-0604	3/8	1/4	1.170	0.830	0.960	0.500		
	4-469-F-0606	3/8	3/8	1.280	0.940	1.100	0.687		
	4-469-F-0608	3/8	1/2	1.340	1.000	1.280	0.750		
	4-469-F-0804	1/2	1/4	1.320	0.970	1.100	0.625		
	4-469-F-0806	1/2	3/8	1.290	0.940	1.100	0.687		
	4-469-F-0808	1/2	1/2	1.420	1.070	1.250	0.750		
	4-469-F-1006	5/8	3/8	1.550	1.130	1.130	0.812		
	4-469-F-1008	5/8	1/2	1.550	1.130	1.280	0.812		
	4-469-F-1206	3/4	3/8	1.780	1.440	1.150	0.875		
4-469-F-1208	3/4	1/2	1.700	1.200	1.340	0.875			
4-470-F CODO 90° TERMINAL HEMBRA  	4-470-F-0402	1/4	1/8						
	4-470-F-0404	1/4	1/4						
	4-470-F-0604	3/8	1/4						
	4-470-F-0808	1/2	1/2						
	4-470-F-1008	5/8	1/2						
4-471-F TE MACHO LATERAL  	4-471-F-0404	1/4	1/4	1.964	1.624	0.700	0.630	1.170	0.437
	4-471-F-0604	3/8	1/4	1.995	1.655	0.930	0.830	1.170	0.500

Frenos de aire. Tubo de Nylon

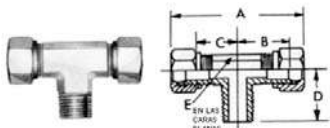
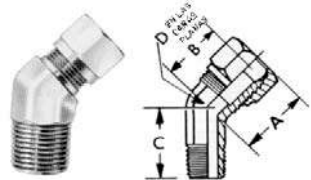
	Número de catálogo	D. E. Tubo	Rosca Tubo NPTF	A	B	C	D	E	F
4-472-F TE MACHO AL CENTRO 	4-472-F-0402	1/4	1/8	1.840	0.630	0.630	0.700	0.437	
	4-472-F-0404	1/4	1/4	1.060	0.720	0.720	0.960	0.500	
	4-472-F-0604	3/8	1/4	2.340	0.830	0.830	0.930	0.500	
	4-472-F-0806	1/2	3/8	2.640	0.970	0.970	1.100	0.750	
	4-472-F-1008	5/8	1/2	3.040	1.100	1.100	1.280	0.812	
4-474-F CODO 45° MACHO 	4-474-F-0402	1/4	1/8	1.090	0.750	0.750	0.562		
	4-474-F-0404	1/4	1/4	1.090	0.750	0.781	0.562		
	4-474-F-0604	3/8	1/4	1.060	0.720	0.860	0.500		
	4-474-F-0608	3/8	1/2	1.027	0.687	0.812	0.562		
	4-474-F-0808	1/2	1/2	1.200	0.850	0.981	0.812		
	4-474-F-1008	5/8	1/2	1.360	0.940	1.170	0.812		
	4-474-F-1208	3/4	1/2	1.460	1.200	1.200	0.812		

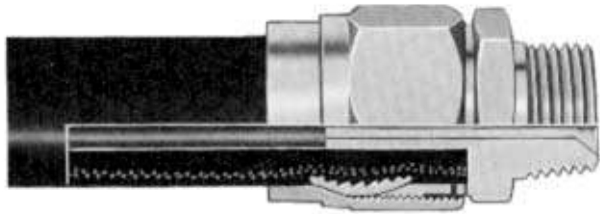

Reutilizables frenos de aire.

(Series AB y AC)

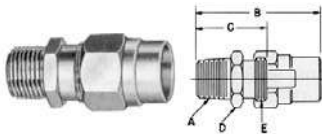
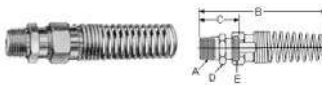

Coples para manguera de freno de aire

Coples reutilizables de latón de tres piezas para usar con manguera de frenos de aire. Pueden ser removidos de una manguera vieja y reutilizados en una nueva solamente reemplazando el barril.

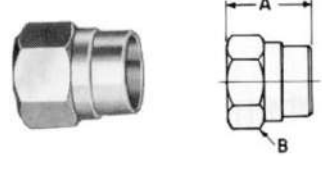
	Número de catálogo	D. I. Manguera	A Rosca Tubo NPTF	B	C Corte Manguera	D	E	F	G
COPLE MACHO SIN RESORTE 	AB-0604-PR	3/8	1/4-18	2.187	0.750	0.968	31/32-20		
	AB-0606-PR	3/8	3/8-18	2.187	0.750	0.968	31/32-20		
	AB-0608-PR	3/8	1/2-14	2.343	0.906	0.968	31-32-20		
COPLE MACHO CON RESORTE 	AB-0604-PR94	3/8	1/4-18	4.625	0.750	0.968	31/32-20		
	AB-0606-PR94	3/8	3/8-18	4.625	0.750	0.968	31/32-20		
	AB-0608-PR94	3/8	1/2-14	4.781	0.906	0.968	31-32-20		
CUERPO DE COPLE MACHO 	AB-0604-PR85	3/8	1/4-18	1.906		0.968	31/32-20		
	AB-0606-PR85	3/8	3/8-18	1.906		0.968	31/32-20		
	AB-0608-PR85	3/8	1/2-14	2.062		0.968	31-32-20		
TUERCA 	AB-O6-81	3/8		1.187	1.062				

Reutilizables frenos de aire. (Series AB y AC)

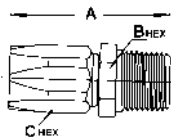
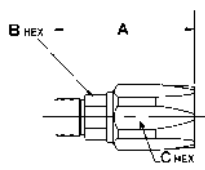
	Número de catálogo	D. I. Manguera	Rosca Tubo NPTF	A	B	C
COPLE MACHO NPTF 	AC-0604-MB	3/8	1/4-18	2.06	9/16	7/8
	AC-0606-MB	3/8	3/8-18	2.06	3/4	7/8
	AC-0608-MB	3/8	1/2-14	2.25	7/8	7/8
	Número de catálogo	D. I. Manguera	Terminal Frenos de aire	A	B	C
COPLE MACHO 	AC-0606-FA	3/8	3/8	2.00	9/16	7/8

Poly-Con

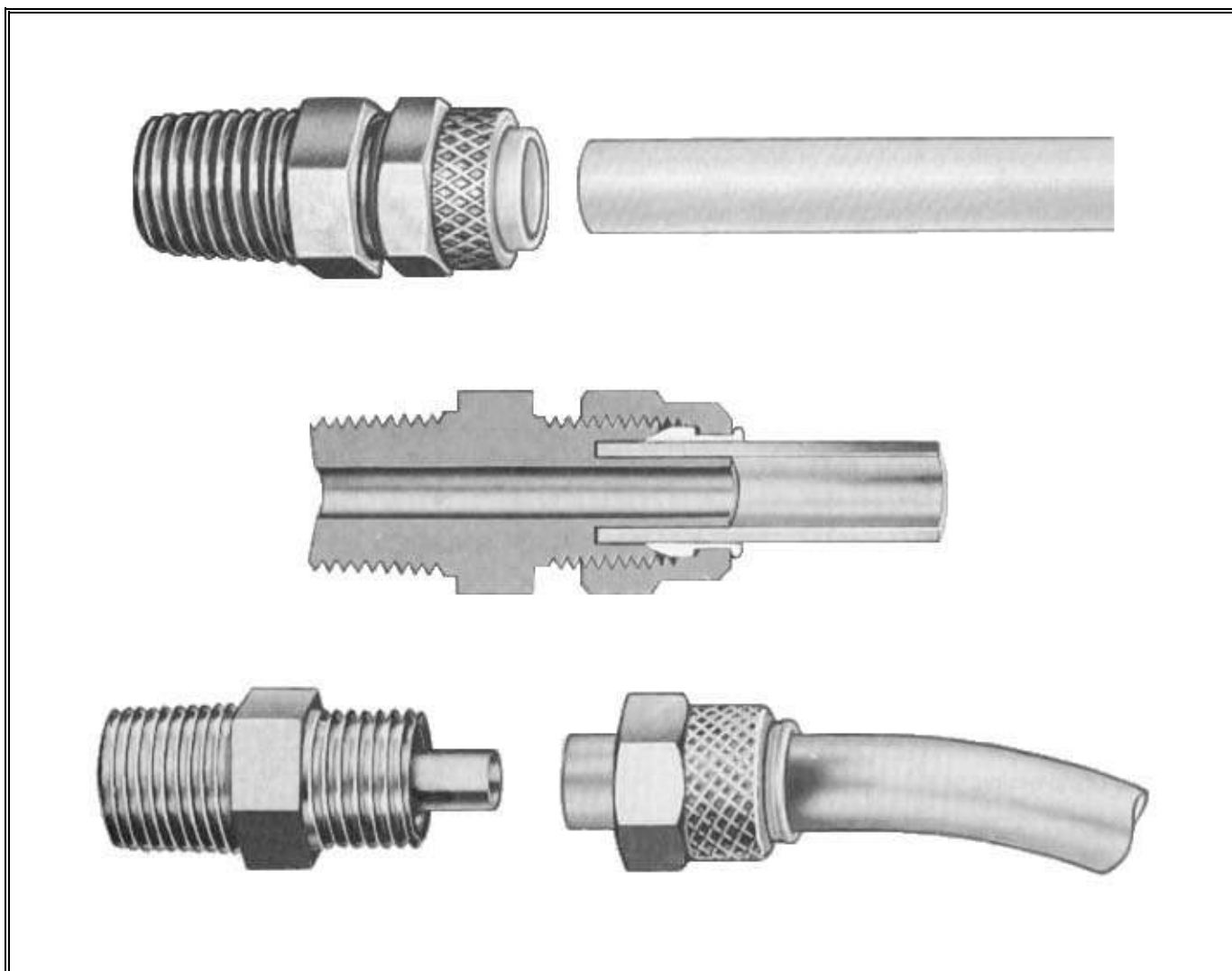

El barril prisionero reduce el tiempo de instalación y sujeta de manera super confiable la tubería de material termoplástico

TAMAÑO : Terminal tubo : de 1/4" a 1/2" de diámetro exterior.
Terminales rosca NPTF de 1/8" a 1/2"

PRESIÓN MÁXIMA DE OPERACIÓN : Ver presión para tuberías de plástico

MATERIALES : Cuerpo y tuerca : Latón
Barril de Copolímero Acetálicos o Latón

COMPATIBILIDAD : Polietileno, Polipropileno, Nylon, PVC, polialómero, EVA y metal blando

Ver datos específicos en las siguientes hojas

Poly-Con



REDUCE EL TIEMPO DE INSTALACIÓN Y EL COSTO DE MANO DE OBRA.

Las conexiones Poly-Con ofrecen un ahorro de por lo menos el 36% en tiempo de instalación en comparación con las conexiones ordinarias de tipo compresión o las conexiones usuales para tubo de plástico, y un mínimo de 77% de ahorro de tiempo en respecto a las conexiones abocinadas.

Para instalar la conexión Poly-Con simplemente se empuja el tubo hasta que quede dentro de la conexión y se aprieta la tuerca. No hace falta desarmar nada ni andar buscando un barril suelto. Esta conexión tiene un barril plástico que entra a presión en la tuerca. La unidad completa - cuerpo, tuerca y barril - viene armada y lista para instalarse. Cuando se usa con tubería de PVC, EVA, o Poly-Con se aprieta a mano, sin necesidad de usar llave de tuercas.

COMPARACIÓN DE AHORROS DE TIEMPO DE INSTALACIÓN.

Se han hecho pruebas para demostrar que las conexiones Poly-Con se pueden instalar en un tiempo promedio de 11.7 segundos. (ver tabla).

TIEMPO PROMEDIO REQUERIDO
PARA INSTALAR CONEXIONES.

Tipo de conexión	Tiempo promedio por junta
POLY-CON	11.7 segundos
Compresión ordinaria	18.5 segundos
Abocinado	48.2 segundos

Estos estudios se hicieron en condiciones de fábrica. Aunque los tiempos efectivos pueden variar según las condiciones de campo, la relación entre los valores de tiempo se mantendrá constante.

Poly-Con

NO SE NECESITAN HERRAMIENTAS PARA LAS INSTALACIONES.

No se usan llaves de tuercas, abocinadoras, dobladores ni ningún tipo de herramienta para su instalación.

Se corta el tubo a la longitud deseada con navaja, corta tubos o tijeras. Si es flexible se dobla fácilmente con la mano. Hay portatubos y soportes de tubo para mantener la tubería en la posición requerida.

EXCELENTE PODER DE SUJECIÓN - NO SE TUERCE LA TUBERÍA.

Las conexiones Poly-Con combinadas con tuberías de PVC o Poly-Con, instaladas y apretadas a mano resisten la presión de reventamiento de la tubería misma.

UNA CONEXIÓN UNIVERSAL.

Las conexiones Poly-Con son usadas con tubería plástica o de metal blando para circuitos de instrumentación neumática y aplicaciones con otros gases o líquidos.

Los barriles de Copolímero Acetálico, para uso con tubería Poly-Con, de PVC o de EVA, son surtidos con conexiones Poly-Con de 1/4" a 1/2" de diámetro exterior. El ensamble universal de tuerca y barril de latón, para su uso con tubería de metal blando, están también disponibles en estos diámetros y son surtidos como estándar en diámetros de 1/16", 1/8" y 3/16".

La versátil tuerca de latón (mitad moleteado y mitad hexagonal) con barriles de plástico, se aprieta fácil y rápidamente con la mano cuando se usa tubería de PVC, EVA o Poly-Con. La parte hexagonal permite que se apriete con llave de tuercas (una vuelta después del apriete a mano). Se recomienda apretar con llave de tuercas en todas las aplicaciones en las que se usa barril de latón y es también aconsejable cuando las condiciones de servicios exigen la máxima capacidad de presión en la tubería.

Los grosores de pared máximos permisibles en tubería de metal para usarse con las conexiones Poly-Con, son los siguientes :

- Diámetro exterior de 1/16", 1/8", 3/16" : sin limitaciones
- Diámetro exterior de 1/4" : 0.035"
- Diámetro exterior de 5/16", 3/8", 1/2" : 0.049"

COMO SE SUMINISTRA.

La conexión para tubo de tres piezas, se suministra ensamblada con tuercas y barriles

MATERIALES.

- Codos y Tes : Latón forjado SAE CA 377
- Conectores, uniones y tuercas : Barra de latón aliviada de esfuerzos SAE CA360 o equivalente
- Barriles de plástico : Copolímero acetálico

ROSCAS PARA TUBOS

Rosca larga para tubo Drysel American Standard

INFORMACIÓN PARA PEDIDO

Para hacer un pedido, simplemente indique el número de catálogo para la configuración y las medidas deseadas.

EJEMPLO :

Tubo de 3/8" (6/16") de diámetro exterior x rosca macho para tubo de 1/4" (4/16")
268-P-0604

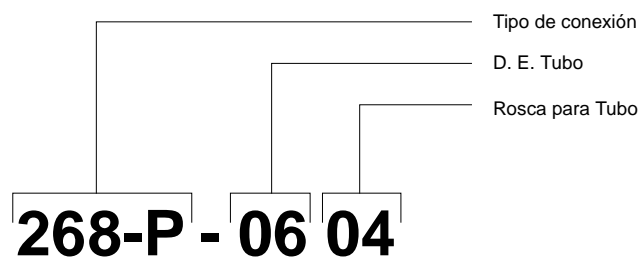

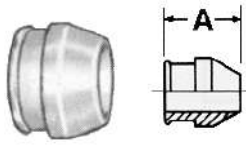
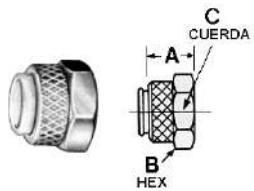
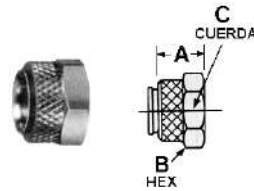
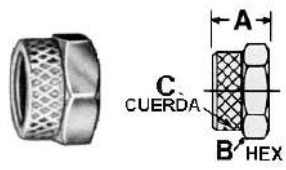
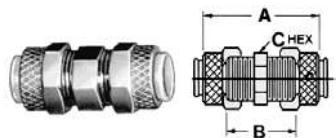

Poly-Con

	Número de catálogo	D. E. Tubo	A	B	C	D	E	F	G
260-P BARRIL 	260-P-04	1/4	0.325						
	260-P-06	3/8	0.356						
	260-P-08	1/2	0.409						
261-P TUERCA CON BARRIL 	261-P-04	1/4	0.343	0.437	3/8-24				
	261-P-06	3/8	0.375	0.562	1/2-24				
	261-P-08	1/2	0.421	0.812	11/16-20				
261-UB ENSAMBLE TUERCA Y BARRIL LATÓN 	261-UB-04	1/4	0.343	0.437	3/8-24				
	261-UB-06	3/8	0.375	0.562	1/2-24				
	261-UB-08	1/2	0.421	0.812	11/16-20				
261-U TUERCA 	261-U-04	1/4	0.343	0.437	3/8-24				
	261-U-06	3/8	0.375	0.562	1/2-24				
	261-U-08	1/2	0.421	0.812	11/16-20				
262-P UNIÓN POLY-CON 	262-P-04	1/4	1.125	0.687	0.375				
	262-P-06	3/8	1.218	0.718	0.500				
	262-P-08	1/2	1.343	0.843	0.687				

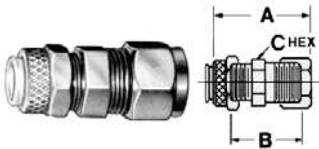
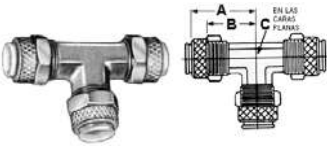
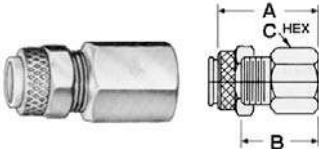
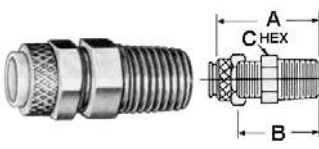
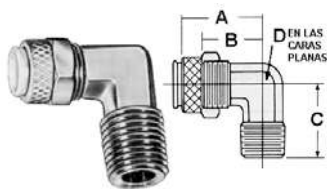
Poly-Con

	Número de catálogo	D. E. Tubo	Rosca Tubo NPTF	A	B	C	D	E	F
262-PC UNIÓN POLY-CON A COMP. 	262-PC-04	1/4		1.250	0.750	0.437			
264-P TE UNIÓN 	264-P-04 264-P-06 264-P-08	1/4 3/8 1/2		0.843 0.906 1.062	0.625 0.656 0.812	0.375 0.437 0.625			
266-P CONECTOR HEMBRA 	266-P-0402 266-P-0404 266-P-0502	1/4 1/4 5/16	1/8 1/4 1/8	0.968 1.156 1.000	0.750 0.937 0.750	0.500 0.625 0.500			
268-P CONECTOR TERMINAL MACHO 	268-P-0401 268-P-0402 268-P-0404 268-P-0502 268-P-0504 268-P-0604 268-P-0606 268-P-0806 268-P-0808	1/4 1/4 1/4 5/16 5/16 3/8 3/8 1/2 1/2	1/16 1/8 1/4 1/8 1/4 1/4 3/8 3/8 1/2	1.031 1.031 1.188 1.046 1.234 1.281 1.281 1.340 1.781	0.812 0.812 1.000 0.812 1.000 1.031 1.031 1.090 1.531	0.375 0.437 0.562 0.437 0.562 0.562 0.687 0.680 0.875			
269-P CODO 90° TERMINAL MACHO 	269-P-0402 269-P-0404 269-P-0406 269-P-0502 269-P-0602 269-P-0604 269-P-0606 269-P-0806 269-P-0808	1/4 1/4 1/4 5/16 3/8 3/8 3/8 1/2 1/2	1/8 1/4 3/8 1/8 1/8 1/4 3/8 3/8 1/2	0.843 0.875 0.968 0.859 0.875 0.968 1.031 1.156 1.156	0.625 0.656 0.750 0.625 0.625 0.718 0.781 0.781 0.843	0.750 0.937 1.031 0.750 0.750 0.937 1.031 1.156 1.320	0.375 0.375 0.500 0.406 0.437 0.437 0.500 0.625 0.625		

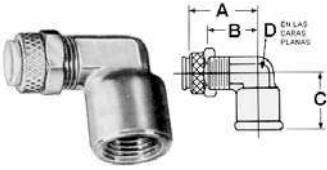
Poly-Con

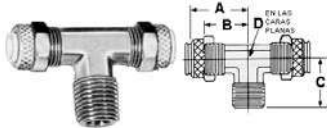
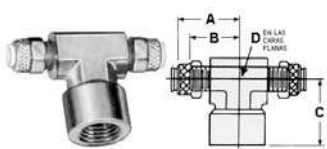
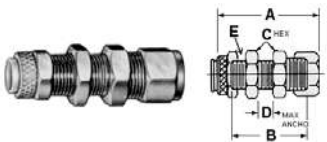
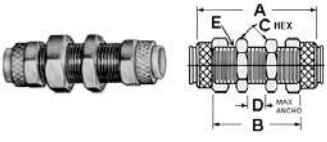
	Número de catálogo	D. E. Tubo	Rosca Tubo NPTF	A	B	C	D	E	F
270-P CODO 90° TERMINAL HEMBRA 	270-P-0402	1/4	1/8	0.906	0.625	0.750	0.375		
	270-P-0404	1/4	1/4	0.937	0.718	0.875	0.500		
271-P TE TERMINAL A UN LADO 	271-P-0402	1/4	1/8	0.843	0.625	0.750	0.375		
	271-P-0404	1/4	1/4	0.875	0.656	0.937	0.375		
	271-P-0806	1/2	3/8	1.062	0.812	1.062	0.625		
272-P TE TERMINAL AL CENTRO 	272-P-0402	1/4	1/8	0.843	0.625	0.750	0.375		
	272-P-0404	1/4	1/4	0.875	0.656	0.937	0.375		
277-P TE HEMBRA AL CENTRO 	277-P-04	1/4		1.078	0.844	1.156	0.562		
282-PC CONECTOR MAMPARA A COMP. 	282-PC-04	1/4		1.687	1.250	0.562	0.312	3/8-24	
282-P UNIÓN MAMPARA 	282-P-04	1/4		1.796	1.312	0.562	0.375	3/8-24	
	282-P-06	3/8		2.000	1.437	0.687	0.375	1/2-24	

Coples para manguera. Baja presión (Serie KA)





Coples para manguera baja presión. Serie KA

Para mangueras de baja presión tipo SAE 100R4. Su diseño de 4 escalones, asegura un sello confiable y proporciona mayor fuerza de sujeción y facilidad de instalación. Hechos de latón, con casquete de plástico para protección de la manguera.

	Número de catálogo	D. I. Manguera	A Macho NPTF	B	C	D	E	
COPLE TERMINAL MACHO 	KA-0402-MB	1/4	1/8	0.190	1.470	0.660	7/16	
	KA-0404-MB	1/4	1/4	0.190	1.670	0.840	9/16	
	KA-0604-MB	3/8	1/4	0.300	1.690	0.870	9/16	
	KA-0606-MB	3/8	3/8	0.300	1.730	0.910	11/16	
	KA-0806-MB	1/2	3/8	0.420	1.860	0.910	11/16	
	KA-0808-MB	1/2	1/2	0.420	2.090	1.140	7/8	
	KA-1008-MB	5/8	1/2	0.550	2.590	1.140	7/8	
	KA-1212-MB	3/4	3/4	0.660	2.720	1.270	1 1/16	
COPLE MACHO RÍGIDO ABOCINADO 45° 	KA-0404-MS	1/4	1/4	7/16-20	0.188	1.560	0.750	7/16
	KA-0405-MS	1/4	5/16	1/2-20	0.188	1.660	0.840	1/2
	KA-0606-MS	3/8	3/8	5/8-18	0.281	1.750	0.940	5/8
	HEMBRA GIRATORIA ABOCINADO 45° 	KA-0606-NS	3/8	3/8	5/8-18	0.297	1.610	0.730
KA-1212-NS		3/4	3/4	1 1/16-14	0.656	2.330	1.090	1 1/4
HEMBRA GIRATORIA ABOCINADO 37° 	KA-0404-NJ	1/4	1/4	7/16-20	0.226	1.219	0.669	11/16
	KA-0606-NJ	3/8	3/8	9/16-18	0.297	1.550	0.700	3/4
	KA-1212-NJ	3/4	3/4	1 1/16-12	0.656	2.550	1.090	1 1/4

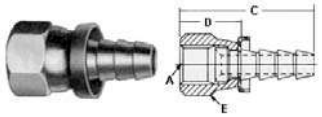
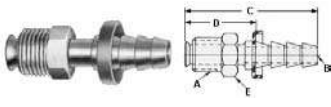
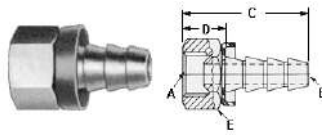
Coples para manguera. Baja presión (Serie KA)

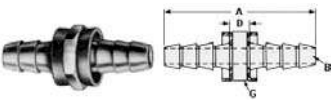
	Número de catálogo	D. I. Manguera	A D. E. Tubo	Rosca NPTF	B	C	D	E
HEMBRA GIRATORIA ABOCINADO 37° - 45° (UNIVERSAL) 	KA-0404-NL	1/4	1/4	7/16-20	0.190	1.500	0.690	9/16
	KA-0405-NL	1/4	5/16	1/2-20	0.190	1.560	0.750	5/8
	KA-0808-NL	1/2	1/2	3/4-16	0.440	1.770	0.810	7/8
	KA-1010-NL	5/8	5/8	7/8-14	0.530	2.330	0.870	1
COPLE MACHO GIRATORIO ABOCINADO INVERTIDO 	KA-0403-MF	1/4	3/16	3/8-24	0.120	1.690	0.870	3/8
	KA-0404-MF	1/4	1/4	7/16-24	0.190	1.720	0.910	7/16
	KA-0405-MF	1/4	5/16	1/2-20	0.190	1.780	0.970	1/2
	KA-0606-MF	3/8	3/8	5/8-18	0.300	2.000	1.190	5/8
HEMBRA RÍGIDA ABOCINADO INVERTIDO 	KA-0403-NG	1/4	3/16	3/8-24	0.120	1.250	0.440	7/16
	KA-0404-NG	1/4	1/4	7/16-24	0.190	1.250	0.440	1/2
	KA-0405-NG	1/4	5/16	1/2-20	0.190	1.280	0.470	9/16
	KA-0606-NG	3/8	3/8	5/8-18	0.280	1.310	0.500	3/4
TUBO RECTO 	Número de catálogo	D. I. Manguera	A D. E. Tubo	B	C	D		
	KA-0404-RL	1/4	1/4	0.188	1.190	2.000		
	KA-0405-RL	1/4	5/16	0.188	1.220	2.030		
	KA-0406-RL	1/4	3/8					
	KA-0606-RL	3/8	3/8	0.297	1.340	2.160		
	KA-0808-RL	1/2	1/2	0.438	1.480	2.440		
	KA-1010-RL	5/8	5/8					
UNIÓN MANGUERA 	Número de catálogo	D. I. Manguera	A	B	D	G		
	KA-0404-RM	1/4	1.870	0.200	0.250	5/8		
	KA-0606-RM	3/8	1.910	0.300	0.280	13/16		
	KA-0808-RM	1/2	2.220	0.420	0.280	7/8		
	KA-1010-RM	5/8	3.250	0.547	0.343	1		
	KA-1212-RM	3/4	3.370	0.660	0.470	1 1/8		

Válvulas y grifos

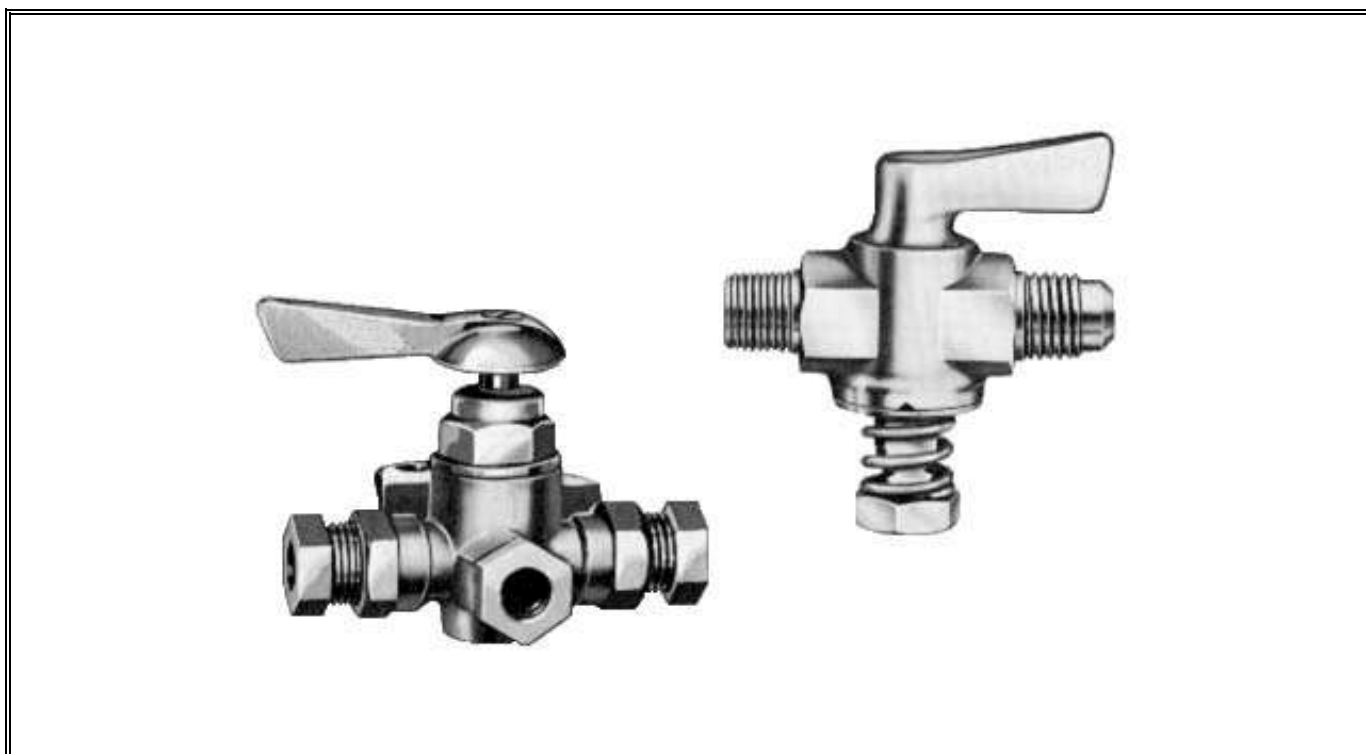

Una amplia gama de válvulas en miniatura para una variedad de aplicaciones de control de fluidos.

TAMAÑO : Tubo : de 1/4" a 1/2" de diámetro exterior.
Terminales de 1/8" a 1/2" NPTF

MATERIALES : Latón forjado

TIPOS DISPONIBLES : Válvulas de cierre de dos y tres vías, válvulas de aguja y grifos de drenado.

Válvulas y grifos

GRIFOS DE DRENADO.

Un maquinado exacto y un adecuado espesor de pared hacen a estos grifos de drenado altamente confiables. Los grifos con vástago cónico son asentados individualmente para asegurar un asiento perfecto y una operación suave.

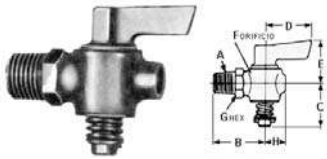
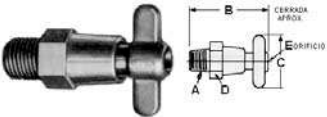
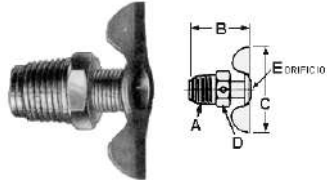
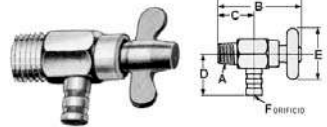
	Número de catálogo	A Rosca Tubo NPTF	B	C	D	E	F	G	H
GRIFO DE DRENADO 	41-E-02	1/8	1.000	0.875	1.000	0.842	0.218	0.625	0.593
	42-E-04	1/4	1.000	0.875	1.000	0.842	0.281	0.625	0.593
	43-E-06	3/8	1.343	0.922	1.000	1.218	0.281	0.750	0.750
GRIFO DE DRENADO 	200-E-02	1/8	1.562	1.125	0.500	0.218			
	201-E-04	1/4	1.625	1.125	0.625	0.312			
	202-E-06	3/8	1.562	1.125	0.687	0.343			
	203-E-08	1/2	1.812	1.250	0.875	0.406			
GRIFO DE DRENADO CON SELLO O RING 	320-E-02	1/8	0.875	1.250	0.437	0.171			
	321-E-04	1/4	0.937	1.437	0.562	0.250			
	322-E-06	3/8	1.250	1.687	0.687	0.343			
	323-E-08	1/2	1.562	2.031	0.875	0.406			
GRIFO DE DRENADO 	302-E-02	1/8	1.562	0.703	0.812	1.125	0.209		
	303-E-04	1/4	1.562	0.703	0.812	1.125	0.209		

Tiene extensión para acoplar manguera de 1/4" de diámetro interior

Válvulas y grifos

VÁLVULAS DE CIERRE.

Cierre positivo con cuerpo de latón forjado para una resistencia extra

MATERIALES.

- Latón

TAMAÑO :

Tubo : de 1/4" a 1/2" de diámetro exterior.
Terminales de 1/8" a 1/2" NPTF

PRESIÓN MÁXIMA DE OPERACIÓN RECOMENDADA

30 PSI Servicio WOG (2.1 kg/cm²)

Vástagos asentados individualmente. El "clic" indica cuando la válvula está totalmente abierta o cerrada en los números 27-EF a 57 EF, 27-SAE a 57-SAE ; se provee de paro (stop) en los números 28-EF a 58-EF, 28-SAE a 58-SAE, 39-E, 40-E, 165-SAE.

La mayoría de los tipos de válvulas son de latón forjado. Roscas largas para tubo Drysel American Standard. Las válvulas son lubricadas con una grasa sintética especial resistente a gasolina, solventes y agua.

VÁLVULAS DE CIERRE DE 2 VÍAS

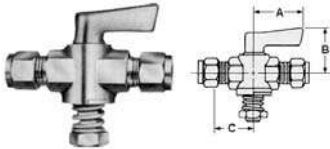
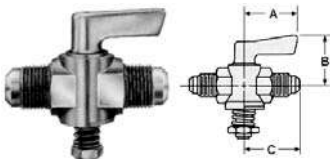
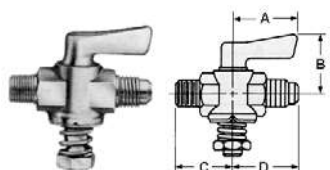
	Número de catálogo	D. E. Tubo	Rosca Tubo NPTF	A	B	C	D	E	F
VÁLVULA DE CIERRE COMP. A COMP. 	30-EF-0505	5/16		1.000	1.218	1.156			
VÁLVULA ABOC. 45° 	28-SAE-04 30-SAE-0505 58-SAE-06 165-SAE-08	1/4 5/16 3/8 1/2		1.000 1.000 1.000 1.125	1.218 1.218 1.218 1.343	1.250 1.312 1.375 1.593			
VÁLVULA DE CIERRE ABOC. A ROSCA MACHO 	27-SAE-0402 57-SAE-0604	1/4 3/8	1/8 1/4	1.000 1.000	1.218 1.218	1.250 1.375	1.187 1.375		

Válvulas y grifos

VÁLVULAS DE CIERRE DE 2 VÍAS

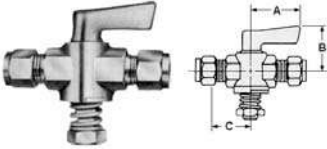
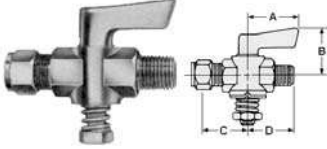
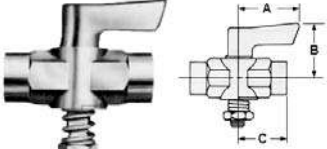
	Número de catálogo	D. E. Tubo	Rosca Tubo NPTF	A	B	C	D	E	F
VÁLVULA DE CIERRE COMP. A COMP. 	28-EF-04	1/4		1.000	1.218	1.125			
	58-EF-06	3/8		1.000	1.218	1.187			
VÁLVULA DE CIERRE COMP. A ROSCA MACHO 	27-EF-0402	1/4	1/8	1.000	1.218	1.215	1.187		
	227-EF-0404	1/4	1/4	1.000	1.218	1.215	1.343		
	57-EF-0604	3/8	1/4	1.000	1.218	1.187	1.343		
	Número de catálogo	Rosca Hembra Tubo NPTF	A	B	C	D	E	F	F
VÁLVULA DE CIERRE ROSCA HEMBRA A ROSCA HEMBRA 	39-E-04	1/4	1/4	1.000	1.218	1.000			
	40-E-06	3/8	3/8	1.125	1.348	1.062			

VÁLVULAS DE CIERRE DE 3 VÍAS

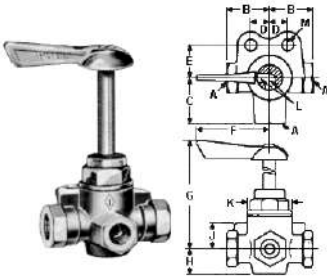
	Número de catálogo	A DE Tubo	B	C	D	E	F	G	H	J	K	L Perf. Comu-nicac.	M Perf. Mon-taje
VÁLVULA 3 VÍAS ROSCA HEMBRA 	113-HD	1/4	1.125	1.125	0.500	0.688	2.063	3.938	0.656	0.594	1.063	0.313	0.266

Válvulas y grifos

VÁLVULAS DE AGUJA.

Excelentes para servicio general con capacidad de calibración

PRESIÓN MÁXIMA DE OPERACIÓN RECOMENDADA

300PSI a 200°F (21.1 kg/cm² a 93.3°C)

MATERIALES.

- Latón

Ideal para servicio donde se requiere cierre y además se requiere control de flujo. La mayoría de las válvulas son de cuerpo de latón forjado, Las válvulas con conexión para tubo por compresión son surtidas ensambladas con tuercas y barriles.

TAMAÑO : Tubo : de 1/4" a 3/8" de diámetro exterior.
Terminales de 1/8" a 1/4" NPTF

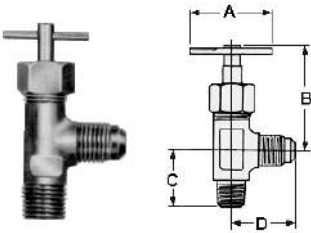
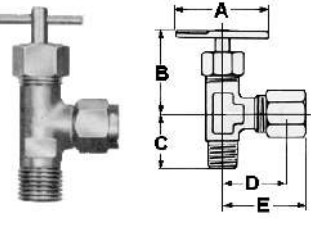
	Número de catálogo	D. E. Tubo	Rosca Tubo NPTF	A	B	C	D	E	F
VÁLVULA DE AGUJA ABOC. 45° A ROSCA MACHO 	103-SAE-0402	1/4	1/8	1.250	1.281	0.812	0.875		
VÁLVULA DE AGUJA COMP. A ROSCA MACHO PARA TUBO 	103-EF-0402 103-EF-0502 103-EF-0604	1/4 5/16 3/8	1/8 1/8 1/4	1.250 1.250 1.250	1.156 1.156 1.437	0.812 0.812 0.968	0.687 0.750 0.781	1.000 1.062 1.093	

Válvulas y grifos

VÁLVULAS DE AGUJA.

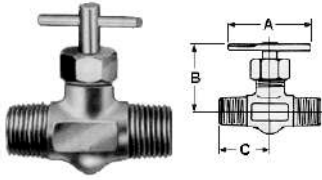
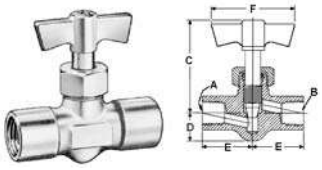
	Número de catálogo	D. E. Tubo	Rosca Tubo NPTF	A	B	C	D	E	F
VÁLVULA DE AGUJA ROSCA MACHO A ROSCA MACHO 	110-EF-02		1/8	0.875	1.250	0.625			
	110-EF-04		1/4	0.875	1.125	0.750			
	Número de catálogo	A Rosca NPTF Entrada	B Rosca NPTF Salida	Orificio	C abierta	C cerrada	D	E	F
VÁLVULA DE AGUJA ROSCA HEMBRA A ROSCA HEMBRA 	394-C-02	1/8	1/8	0.170	1.688	1.563	0.469	0.844	
	394-C-04	1/4	1/4	0.218	1.719	1.594	0.469	1.000	

Sello perfecto (Serie 700)

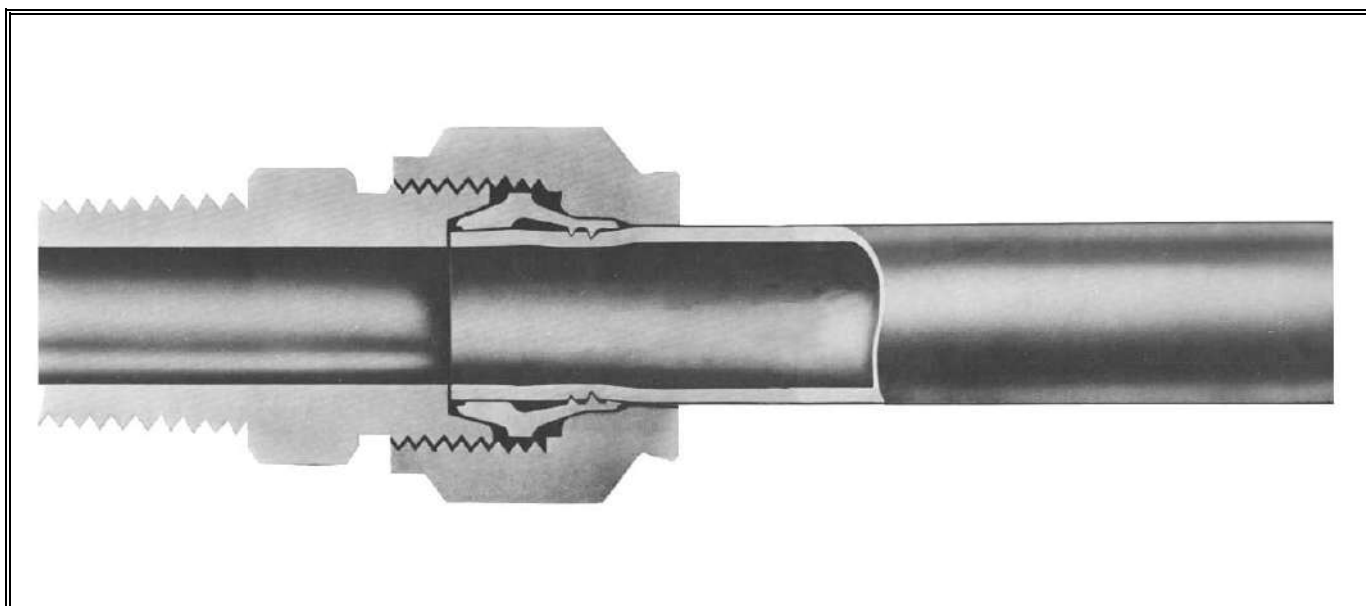

Conexión industrial de alto rendimiento en elevadas presiones y vacíos

TAMAÑO :

Tubo : de 1/8" a 1" de diámetro exterior.
Terminales de 1/8" a 1" NPTF

PRESIÓN MÁXIMA DE OPERACIÓN :

Ver tablas

MATERIALES :

Codos y Tes :
Latón forjado
SAE CA 377
Conectores, uniones, barriles y tuercas : SAE CA 360

ESPECIFICACIONES

J. I. C. Normas hidráulicas y neumáticas
S. A. E. Normas hidráulicas
A. S. M. E. Código para tubería de Impulsión
A. N. S. I. Código para tubería de Impulsión
U. L. Lista para ser utilizada con líquidos peligrosos y gases en caso de emplearlos con acero o inoxidable al carbón
M. I. L. Se apeg a MIL-F-18280-B, MIL-F-5506A y MIL-F-21467
N. F. P. A. Según normas No. T3.8.70.2, T3.8.70.3
Guarda Costa Lista de equipo No. CG-190

Sello perfecto (Serie 700)

LA CONEXIÓN PARA TUBO MÁS VERSÁTIL Y DE MAYORES APLICACIONES

Las características de la conexión Sello Perfecto Nacobre, hacen que sea la óptima recomendación en aplicaciones varia, tales como :

Instrumental para química, petroquímica, refinerías, sistemas neumáticos, hidráulicos y otras operaciones para la transmisión de fluidos.

PRESIÓN.

Las conexiones Sello Perfecto (Serie 700) son recomendadas para servicio de baja o alta presión, dentro de las normas de seguridad marcadas para los tipos de tubo de mayor demanda en el mercado.

VACIO.

Usando un espectrómetro ajustado para detectar fugas hasta 0.014 micrones cúbicos por pie-hora, NO SE DETECTO NINGUNA FUGA.

TEMPERATURA.

Como regla general, la limitación de temperatura que puede ser observada para sistema de tubería de cobre y latón es de 218°C.

VIBRACIONES Y CHOQUES.

Las conexiones Sello Perfecto (Serie 700) EXCEDEN ampliamente las especificaciones MILITARES de Estados Unidos (MIL-F-18280-B ; Diez millones de ciclos)

DISEÑO.

El diseño Sello Perfecto (Serie 700) permite que el tubo aprisionado penetre en el cuerpo de la conexión ; además el barril proporciona un soporte efectivo sobre el tubo, en ambos lados del sellado, eliminando con ello falsas sujeciones que son la principal causa de fugas en las conexiones

El segundo "diente" del barril de la conexión Sello Perfecto (Serie 700), agrega un complemento al poder de ajuste, lo que provee un nuevo sellado en cada unión.

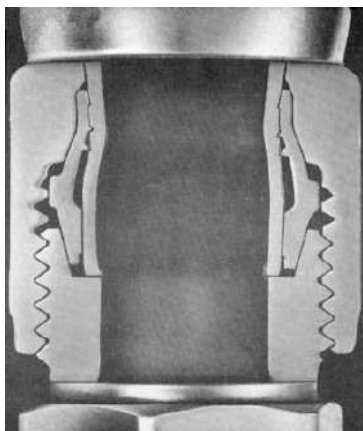

Conexión Sello Perfecto después del primer ensamble. Nótese como el primer "diente" sujeta al tubo para efectuar el sello

PREAJUSTE : Las conexiones Sello Perfecto no requieren desensamblarse, para comprobar que están bien unidas. Sin embargo en lugares donde el espacio dificulte el ensamble de la conexión, ésta puede ser preajustada con la herramienta adecuada para facilitar y acelerar la instalación. En casos de emergencia el cuerpo de cualquier conexión puede usarse como herramienta de preajuste.

DISEÑO COMPACTO : Debido a que la conexión Sello Perfecto , por su diseño , no requiere emplearse con tubería avellanada ; puede instalarse en espacios muy reducidos con dobleces del tubo muy cercanos a la conexión, obteniéndose ahorro en material y espacio.

VERSÁTIL : Las conexiones Sello Perfecto pueden surtirse en distintos modelos y medidas en latón.

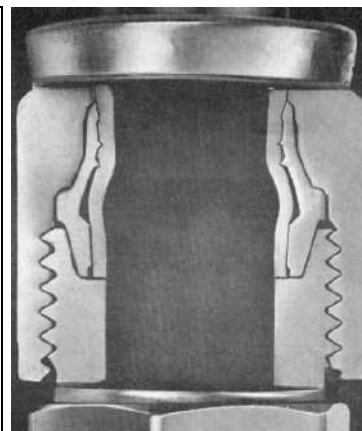

Conexión Sello Perfecto después de repetidos ensambles. Nótese cómo el segundo "diente" sujeta ahora al tubo. El sello perfecto se mantiene aun después de repetido ensambles sin afectar al tubo.

Sello perfecto (Serie 700)

PRESIONES MÁXIMAS DE OPERACIÓN RECOMENDADAS (PSI)

MATERIAL DE LAS CONEXIONES :

LATÓN

MATERIAL DE LA TUBERÍA :

COBRE, GRADO SUAVE, SIN COSTURA

CONDICIONES DE SERVICIO	DIAM. EXT.	ESPESOR DE PARED EN TUBERÍA COMERCIALMENTE DISPONIBLE. MÁXIMAS PRESIONES DE OPERACIÓN RECOMENDADAS (PSI)							
		0.028"	0.032"	0.035"	0.042"	0.049"	0.065"	0.083"	
FLUJO MINIMO	1/8"	3,710	4,480	5,000					
	3/16"	2,710	2,990	3,300	3,920	4,580			
	1/4"	2,170	2,250	2,500	3,400	4,030			
	5/16"	1,710	1,800	2,000	2,640	3,120			
	3/8"	1,400	1,500	1,650	2,170	2,580	3,520		
	1/2"	1,030	1,150	1,250	1,590	1,890	2,560	3,360	
	Factor de Seguridad 4-1	5/8"		936	1,000	1,250	1,400	1,800	2,520
		3/4"			850	1,030	1,150	1,500	2,140
		7/8"				884	1,030	1,390	1,810
		1"					902	1,210	1,580
FLUJO Hasta 50%	1/8"	2,470	2,980	3,330					
	3/16"	1,810	1,990	2,200	2,620	3,060			
	1/4"	1,450	1,500	1,670	2,260	2,680			
	5/16"	1,140	1,200	1,330	1,630	2,080			
	3/8"	933	1,000	1,100	1,450	1,720	2,340		
	1/2"	686	766	833	1,060	1,260	1,710	2,240	
	Factor de Seguridad 6-1	5/8"		624	667	833	932	1,200	1,680
		3/4"			566	685	766	1,000	1,430
		7/8"				589	685	926	1,210
		1"					600	805	1,050

MATERIAL DE LAS CONEXIONES :

LATÓN

MATERIAL DE LA TUBERÍA :

COBRE, GRADO MEDIO, SIN COSTURA

CONDICIONES DE SERVICIO	DIAM. EXT.	ESPESOR DE PARED EN TUBERÍA COMERCIALMENTE DISPONIBLE. MÁXIMAS PRESIONES DE OPERACIÓN RECOMENDADAS (PSI)							
		0.028"	0.032"	0.035"	0.042"	0.049"	0.065"	0.083"	
FLUJO MINIMO	1/8"	4,210	5,100	5,700					
	3/16"	3,080	3,400	3,750	4,450	5,200			
	1/4"	2,470	2,560	2,840	3,860	4,580			
	5/16"	1,940	2,040	2,280	3,000	3,570			
	3/8"	1,170	1,710	1,880	2,470	2,940	4,000		
	1/2"		1,310	1,420	1,810	2,150	2,910	3,820	
	Factor de Seguridad 4-1	5/8"		1,070	1,140	1,420	1,590	2,050	2,860
		3/4"			966	1,170	1,310	1,710	2,440
		7/8"				1,000	1,170	1,580	2,060
		1"					1,030	1,380	1,800
FLUJO Hasta 50%	1/8"	2,800	3,390	3,780					
	3/16"	2,060	2,260	2,500	2,980	3,480			
	1/4"	1,650	1,710	1,900	2,570	3,270			
	5/16"	1,300	1,370	1,510	1,850	2,360			
	3/8"	1,110	1,140	1,250	1,650	1,960	2,660		
	1/2"	820	915	994	1,210	1,430	1,940	2,550	
	Factor de Seguridad 6-1	5/8"		745	796	994	1,110	1,360	1,910
		3/4"			676	817	915	1,140	1,630
		7/8"				702	817	1,110	1,380
		1"					716	967	1,190

Sello perfecto (Serie 700)

FACTOR DE REDUCCIÓN DE TEMPERATURA (TEMPERATURAS ELEVADAS)

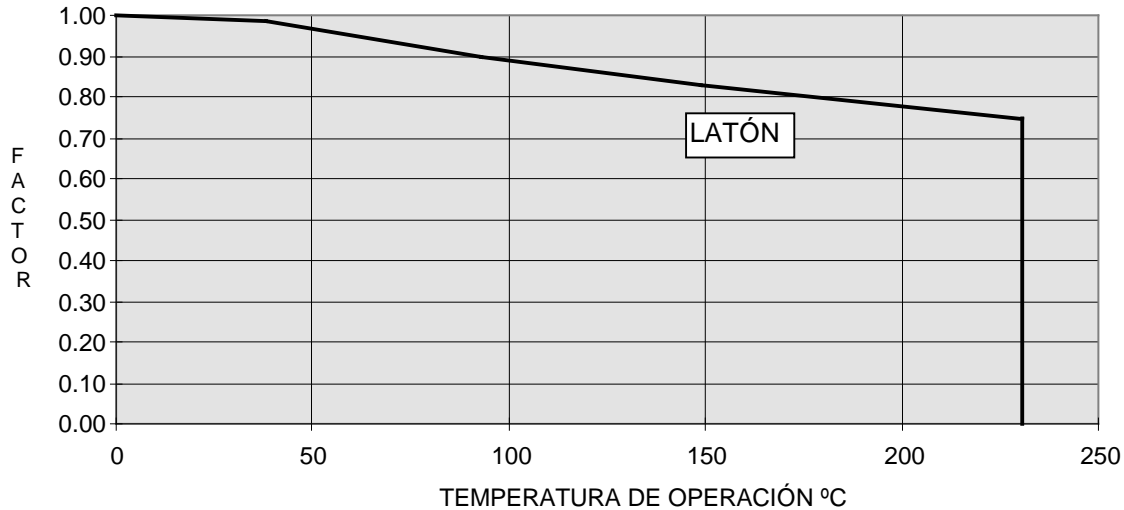

ROSCAS PARA TUBOS

Rosca larga para tubo Drysel American Standard

INFORMACIÓN PARA PEDIDO

Para hacer un pedido, simplemente indique el número de catálogo y agregue el diámetro exterior y el tamaño de la terminal con rosca para tubo en caso necesario. A continuación se da la guía para las claves de número de catálogo de las conexiones

Clave	Medida en dieciseisavos	Medida equivalente
02	2/16"	1/8"
03	3/16"	3/16"
04	4/16"	1/4"
05	5/16"	5/16"
06	6/16"	3/8"
08	8/16"	1/2"
10	10/16"	5/8"
12	12/16"	3/4"
16	16/16"	1"

EJEMPLO :

Conector 768-F en latón de 3/8" (6/16") diámetro exterior x rosca para tubo de 1/4" (4/16")
768-FB-0604



Sello perfecto (Serie 700)

GUÍA DE CORROSIÓN

A : Excelente, B : Bueno, C : Regular, D : No adecuada, E : Explosiva, I : Inflamable, O : No disponible

Compuesto químico	Concen- -tración %	Temp. °C	Cobre	Latón	Compuesto químico	Concen- -tración %	Temp. °C	Cobre	Latón
Acetaldehido	100	21	E	E	Difenilo	100	21	B	B
Acetato de Butilo	100	21	B	B	Bióxido de azufre (seco)	100	149	B	B
Acetato etílico (seco)	100	21	B	B	Bióxido de carbono (húmedo)	100	21	C	C
Acetato de sodio	10	21	B	B					
Acetona	100	21	A	A	Etanolamina	100	21	B	B
Ácido acético (gas)	100	21	D	D	Etileno de glicol	100	21	B	B
Ácido benzóico	10	21	B	B	Éter	100	21	B	B
Ácido bórico	10	21	B	B	Éter etílico	100	21	B	B
Ácido cítrico	20	21	C	C					
Ácido fosfórico (gas)	50	93	D	D	Fenol	10	49	B	B
Ácidos grasos	100	203	D	D	Formaldehido	50	93	B	B
Ácido hidroclicórico (gas)	38	21	D	D	Furfural	100	21	B	B
Ácido hidrofúrico (gas)	40	21	C	D					
Ácido láctico	50	21	B	B	Gas de cloro (seco)	100	21	B	B
Ácido nítrico	50	93	D	D	Glicerina	100	21	A	A
Ácido nítrico	10	21	D	D					
Ácido oleico	100	21	B	B	Hidróxido de aluminio	10	21	B	B
Ácido oxálico	10	21	B	B	Hidróxido de calcio	10	21	B	B
Ácido sulfúrico (gas)	60	93	D	D	Hidróxido de litio	10	93	B	B
Agua	100	21	A	A	Hidróxido de magnesio	10	21	B	B
Agua de mar	100	21	B	B	Hidróxido de sodio	50	149	D	D
Alcohol etílico	100	21	B	B					
Alcohol metílico	100	21	B	B	Isopropanol	100	21	B	B
Amoniaco (anhidro)	100	21	A	A					
Anhídrido acético	100	21	B	C	Metilamina	100	21	B	B
Anilina	100	21	D	D	Monoclorobenceno (seco)	100	21	B	B
Aroclor	100	21	A	A	Monoclorodifluorometano F-22	100	21	A	A
					Monoetanolamina	100	93	B	B
Benzaldehido	100	21	B	B					
Benceno	100	21	A	A	Naftalina	100	21	B	B
Butano	100	21	A	A					
Butanol	100	21	A	A	Óxido de difenilo	100	29	B	B
Carbonato de potasio	40	93	B	B	Percloroetileno	100	21	B	B
Cloroformo (seco)	100	21	B	B	Piridina	100	21	B	B
Cloruro de amonio	10	21	D	D					
Cloruro de bario	30	21	B	B	Sulfato de amonio	10	21	C	C
Cloruro de butilo	100	21	A	A	Sulfato férrico	10	21	D	D
Cloruro de calcio	20	21	B	B	Sulfato de magnesio	30	93	B	B
Cloruro de litio	30	93	B	B	Sulfato de níquel	10	93	B	B
Cloruro de magnesio	30	21	B	B	Sulfato de sodio	10	93	B	B
Cloruro de metileno (seco)	100	21	B	B	Sulfato de zinc	20	21	B	B
Cloruro de vinilo (seco)	100	21	A	A					
Cloruro de zinc	10	21	D	D	Tetracloruro de carbono (seco)	100	21	B	B
					Tricloroetileno (seco)	100	66	B	B
Dibutilftalato	100	21	A	A	Turpentina	100	21	B	B
Diclorodifluorometano (F-12)	100	21	A	A					
Dietalonamina	100	29	A	A	Xileno	100	93	A	A
Dietilo de éter	100	21	B	B					
Dietileno de glicol	100	21	B	B	Yodo	20	21	D	D

Sello perfecto (Serie 700)

DIMENSIONES

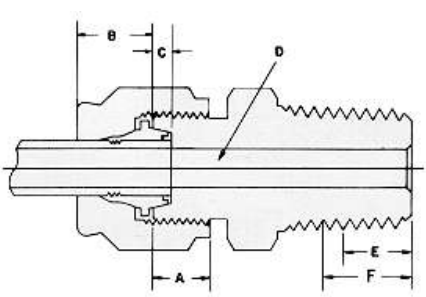
	Diámetro Exterior del tubo	Rosca Recta	EXTREMO DEL TUBO			
			A	B	C	D
			Longitud de la rosca			D. I.
	1/16"	1/4-28	0.172	0.219	0.063	0.055
	1/8"	3/8-24	0.219	0.297	0.078	0.109
	3/16"	7/16-20	0.203	0.328	0.078	0.172
	1/4"	1/2-20	0.266	0.328	0.109	0.203
	5/16"	9/16-18	0.266	0.406	0.109	0.203
	3/8"	5/8-18	0.313	0.438	0.109	0.281
	1/2"	3/4-16	0.344	0.547	0.125	0.422
	5/8"	15/16-16	0.375	0.625	0.141	0.500
	3/4"	1 1/16-16	0.375	0.625	0.141	0.656
	7/8"	1 3/16-16	0.375	0.625	0.156	0.719
	1	1 5/16-16	0.375	0.625	0.156	0.875
	1 1/4	1 5/8-16	0.406	0.813	0.172	1.094
	1 1/2	1 7/8-16	0.438	0.813	0.188	1.344
	2	2 1/2-12	0.531	0.859	0.188	1.813

TERMINAL ROSCA NPTF		
Rosca NPTF	E	F
	Ajuste Manual	Ajuste Mecánico
1/16"	0.156	0.250
1/8"	0.172	0.250
1/4"	0.234	0.375
3/8"	0.234	0.375
1/2"	0.328	0.500
3/4"	0.344	0.516
1"	0.406	0.625
1 1/4"	0.422	0.641
1 1/2"	0.422	0.641
2"	0.438	0.656

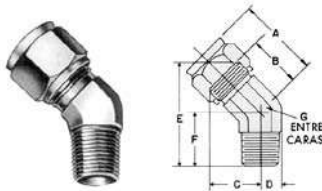
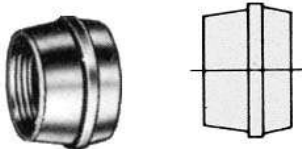
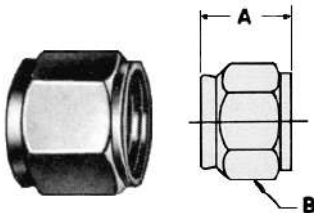
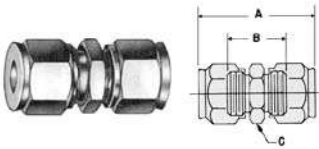
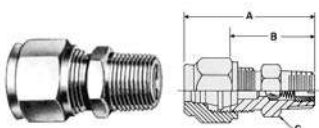

Sello perfecto (Serie 700)

		Número de catálogo	D. E. Tubo	Rosca Tubo NPTF	A	B	C	D	E	F	G
754-FB CODO 45° TERMINAL MACHO		754-FB-0402	1/4	1/8	0.859	0.531	0.625	0.219	1.203	0.656	0.438
		754-FB-0504	5/16	1/4							
		754-FB-0604	3/8	1/4	1.078	0.641	0.750	0.250	0.547	0.875	0.500
		754-FB-0806	1/2	3/8	1.234	0.688	0.828	0.313	1.609	0.875	0.625
		754-FB-1008	5/8	1/2	1.625	1.000	1.094	0.531	2.281	1.188	1.063
		Número de catálogo	D. E. Tubo	Rosca Tubo NPTF	A	B	C Hex	D	E	F	
760-F BARRIL		760-FB-03	3/16								
		760-FB-04	1/4								
		760-FB-05	5/16								
		760-FB-06	3/8								
		760-FB-08	1/2								
		760-FB-10	5/8								
		760-FB-12	3/4								
		760-FB-16	1								
761-FB TUERCA		761-FB-04	1/4	1/2-20	0.594						
		761-FB-05	5/16	9/16-18	0.672						
		761-FB-06	3/8	5/8-18	0.750						
		761-FB-08	1/2	3/4-16	0.891						
		761-FB-10	5/8	15/16-16	1.000						
		761-FB-12	3/4	1 1/16-16	1.000						
		761-FB-16	1	1 5/16-16	1.000						
762-FB UNIÓN		762-FB-04	1/4		1.563	0.906	0.500				
		762-FB-05	5/16		1.781	0.906	0.563				
		762-FB-06	3/8		1.875	1.000	0.625				
		762-FB-08	1/2		2.188	1.094	0.750				
		762-FB-10	5/8		2.500	1.250	0.234				
		762-FB-12	3/4		2.500	1.250	1.063				
		762-FB-16	1		2.563	1.313	1.313				
763-FB CONECTOR MACHO CHECK		763-FB-0402	1/4	1/8	1.281	0.953	0.500				
											

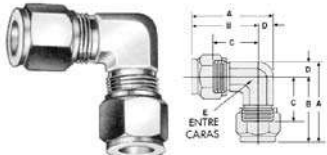
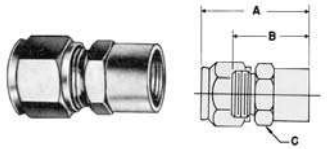
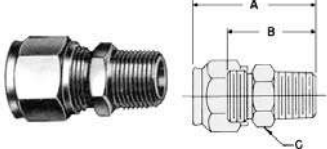

Sello perfecto (Serie 700)

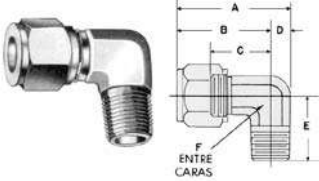
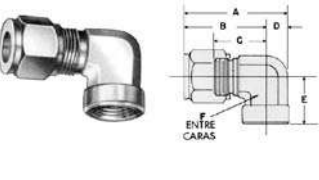
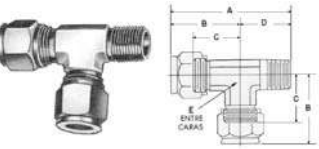
	Número de catálogo	D. E. Tubo	Rosca Tubo NPTF	A	B	C	D	E	F
764-FB TE UNIÓN									
	764-FB-04	1/4		2.094	1.047	0.719	0.438		
	764-FB-05	5/16		2.375	1.188	0.781	0.500		
	764-FB-06	3/8		2.469	1.234	0.797	0.500		
	764-FB-08	1/2		2.969	1.484	0.938	0.625		
	764-FB-10	5/8		3.875	1.938	1.313	1.000		
	764-FB-12	3/4		4.125	2.063	1.438	1.000		
	764-FB-16	1		3.875	1.938	1.313	0.313		
	765-FB CODO 90° UNIÓN								
	765-FB-04	1/4		1.266	1.047	0.719	0.219	0.438	
	765-FB-05	5/16		1.438	1.188	0.781	0.250	0.500	
	765-FB-06	3/8		1.516	1.266	0.828	0.250	0.500	
	765-FB-08	1/2		1.797	1.484	0.938	0.313	0.625	
	765-FB-10	5/8		2.438	1.938	1.313	0.500	1.000	
	765-FB-12	3/4		2.563	2.063	1.438	0.500	1.000	
	765-FB-16	1		2.594	2.938	1.313	0.656	1.313	
	766-FB CONECTOR HEMBRA								
	766-FB-0202	1/8	1/8	1.141	0.844	0.563			
	766-FB-0402	1/4	1/8	1.281	0.953	0.563			
	766-FB-0404	1/4	1/4	1.391	1.063	0.750			
	766-FB-0408	1/4	1/2	1.828	1.500	1.063			
	766-FB-0504	5/16	1/4	1.469	1.063	0.750			
	766-FB-0604	3/8	1/4	1.609	1.172	0.750			
	766-FB-0606	3/8	3/8	1.672	1.234	0.875			
	766-FB-0608	3/8	1/2	1.938	1.500	1.063			
	766-FB-0804	1/2	1/4	1.766	1.219	0.750			
	766-FB-0806	1/2	3/8	1.828	1.281	0.875			
	766-FB-0808	1/2	1/2	2.109	1.563	1.063			
	766-FB-1008	5/8	1/2	2.188	1.563	1.063			
	766-FB-1208	3/4	1/2	2.188	1.563	1.063			
	766-FB-1212	3/4	3/4	2.281	1.656	1.250			
	766-FB-1612	1	3/4	2.281	1.656	1.313			
766-FB-1616	1	1	2.500	1.875	1.625				
768-FB CONECTOR MACHO									
	768-FB-0402	1/4	1/8	1.281	0.953	0.500			
	768-FB-0404	1/4	1/4	1.484	1.156	0.625			
	768-FB-0406	1/4	3/8	1.453	1.125	0.750			
	768-FB-0408	1/4	1/2	1.828	1.500	0.875			
	768-FB-0502	5/16	1/8	1.359	0.953	0.563			
	768-FB-0504	5/16	1/4	1.563	1.156	0.625			
	768-FB-0602	3/8	1/8	1.438	1.000	0.625			
	768-FB-0604	3/8	1/4	1.641	1.203	0.625			
	768-FB-0606	3/8	3/8	1.641	1.203	0.750			
	768-FB-0608	3/8	1/2	1.969	1.531	0.875			
	768-FB-0612	3/8	3/4	1.984	1.547	1.125			
	768-FB-0804	1/2	1/4	1.797	1.250	0.750			
	768-FB-0806	1/2	3/8	1.797	1.250	0.750			
	768-FB-0808	1/2	1/2	2.141	1.594	0.875			
	768-FB-0812	1/2	3/4	2.109	1.563	1.125			
	768-FB-1006	5/8	3/8	1.969	1.344	0.938			
	768-FB-1008	5/8	1/2	2.250	1.625	0.938			
	768-FB-1012	5/8	3/4	2.219	1.594	1.125			
	768-FB-1206	3/4	3/8	2.031	1.406	1.063			
	768-FB-1208	3/4	1/2	2.250	1.625	1.125			
768-FB-1212	3/4	3/4	2.250	1.625	1.125				
768-FB-1612	1	3/4	2.250	1.625	1.375				
768-FB-1616	1	1	2.438	1.813	1.375				

Sello perfecto (Serie 700)

	Número de catálogo	D. E. Tubo	Rosca Tubo NPTF	A	B	C	D	E	F
769-FB CODO 90° TERMINAL MACHO 	769-FB-0402	1/4	1/8	1.234	1.016	0.672	0.219	0.781	0.438
	769-FB-0404	1/4	1/4	1.297	1.078	0.750	0.219	1.094	0.438
	769-FB-0408	1/4	1/2	1.578	1.234	0.906	0.344	1.250	0.688
	769-FB-0502	5/16	1/8	1.375	1.125	0.719	0.250	0.844	0.500
	769-FB-0504	5/16	1/4	1.406	1.156	0.750	0.250	0.938	0.500
	769-FB-0602	3/8	1/8	1.422	1.172	0.734	0.250	0.813	0.563
	769-FB-0604	3/8	1/4	1.484	1.234	0.797	0.250	1.063	0.500
	769-FB-0606	3/8	3/8	1.578	1.297	0.859	0.281	1.063	0.563
	769-FB-0608	3/8	1/2	1.734	1.391	0.953	0.344	1.250	0.688
	769-FB-0612	3/8	3/4						
	769-FB-0804	1/2	1/4	1.766	1.453	0.906	0.313	1.125	0.625
	769-FB-0806	1/2	3/8	1.766	1.453	0.906	0.313	1.125	0.625
	769-FB-0808	1/2	1/2	1.828	1.484	0.938	0.344	1.313	0.688
	769-FB-1006	5/8	3/8	1.781	1.656	1.031	0.125	1.250	0.750
	769-FB-1008	5/8	1/2	2.094	1.656	1.031	0.438	1.500	0.875
	769-FB-1208	3/4	1/2	2.219	1.750	1.125	0.469	1.500	0.938
	769-FB-1212	3/4	3/4	2.219	1.750	1.125	0.469	1.469	0.938
769-FB-1616	1	1	2.594	1.938	1.313	0.656	1.969	1.313	
770-FB CODO 90° HEMBRA 	770-FB-0402	1/4	1/8	1.266	1.047	0.719	0.219	0.688	0.438
	770-FB-0404	1/4	1/4	1.391	1.141	0.813	0.250	0.875	0.500
	770-FB-0502	5/16	1/8	1.406	1.156	0.750	0.250	0.813	0.500
	770-FB-0504	5/16	1/4	1.469	1.219	0.813	0.250	0.875	0.500
	770-FB-0602	3/8	1/8	1.547	1.297	0.859	0.250	0.688	0.500
	770-FB-0604	3/8	1/4	1.547	1.297	0.859	0.250	0.875	0.500
	770-FB-0606	3/8	3/8	1.719	1.406	1.969	0.313	0.938	0.625
	770-FB-0608	3/8	1/2						
	770-FB-0804	1/2	1/4	1.891	1.578	1.031	0.313	0.938	0.625
	770-FB-0806	1/2	3/8	1.891	1.578	1.031	0.313	0.938	0.625
	770-FB-0808	1/2	1/2	2.000	1.672	1.125	0.328	1.188	0.688
	770-FB-1008	5/8	1/2	2.438	1.938	1.313	0.500	1.250	1.063
770-FB-1212	3/4	3/4	2.719	2.063	1.438	0.656	1.344	1.313	
771-FB TE TERMINAL LATERAL MACHO 	771-FB-0402	1/4	1/8	1.797	1.047	0.719	0.750	0.438	
	771-FB-0404	1/4	1/4	1.016	1.078	0.750	0.938	0.438	
	771-FB-0502	5/16	1/8	2.000	1.188	0.781	0.813	0.500	
	771-FB-0604	3/8	1/4	2.266	1.266	0.828	1.000	0.500	
	771-FB-0806	1/2	3/8	2.547	1.484	0.938	1.063	0.625	
	771-FB-0808	1/2	1/2	3.406	1.703	1.156	1.344	0.813	
	771-FB-1212	3/4	3/4	3.500	2.063	1.438	1.438	1.063	
	771-FB-1616	1	1	3.875	1.938	1.313	1.938	1.313	
772-FB TE TERMINAL CENTRAL MACHO 	772-FB-0402	1/4	1/8	2.094	1.047	0.719	0.750	0.438	
	772-FB-0404	1/4	1/4	2.156	1.078	0.750	0.938	0.438	
	772-FB-0502	5/16	1/8	2.375	1.188	0.781	0.813	0.500	
	772-FB-0604	3/8	1/4	2.531	1.266	0.828	1.000	0.500	
	772-FB-0606	3/8	3/8						
	772-FB-0806	1/2	3/8	2.656	1.484	0.938	1.063	0.625	
	772-FB-0808	1/2	1/2	3.406	1.703	1.156	1.344	0.813	
	772-FB-1008	5/8	1/2	3.875	1.938	1.313	1.438	1.000	
	772-FB-1212	3/4	3/4	4.125	2.063	1.438	1.438	1.063	

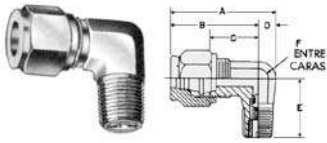
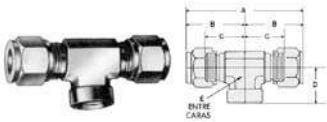
Sello perfecto (Serie 700)

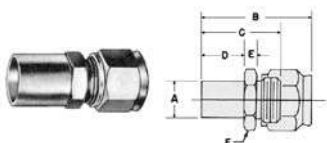
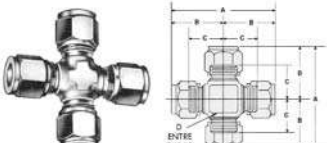
	Número de catálogo	D. E. Tubo	Rosca Tubo NPTF	A	B	C	D	E	F
773-FB CODO 90° MACHO CHECK 	773-FB-0402	1/4	1/8	1.234	1.016	0.688	0.219	0.750	0.500
	773-FB-0604	3/8	1/4	0.484	1.234	0.797	0.250	1.063	0.500
777-FB TE TERMINAL CENTRAL HEMBRA 	777-FB-0402	1/4	1/8	2.156	1.078	0.750	0.641	0.625	
	777-FB-0404	1/4	1/4	2.344	1.172	0.844	0.891	0.750	
	777-FB-0604	3/8	1/4	2.625	1.313	0.875	0.891	0.750	
	777-FB-0606	3/8	3/8						
	777-FB-0806	1/2	3/8	3.094	1.547	1.000	0.969	0.813	
	777-FB-1212	3/4	3/4	4.125	2.063	1.438	1.344	1.313	
	777-FB-1612	1	3/4	4.125	2.063	1.438	1.344	1.313	
782-FB UNIÓN BULKHEAD (MÁMPARA) 	Número de catálogo	D. E. Tubo	Rosca Tubo NPTF	A	B	C Grosor Máx. Mampara	D Rosca NPTF	E	F
	782-FB-04	1/4		2.219	1.563	0.375	1/2-20	0.688	
	782-FB-05	5/16		2.406	1.594	0.375	9/16-18	0.750	
	782-FB-06	3/8		2.531	1.656	0.375	5/8-18	0.813	
	782-FB-08	1/2		2.844	1.750	0.375	3/4-16	0.938	
	782-FB-12	3/4		3.438	2.188	0.625	1 1/16-16	1.125	
783-FB REDUCCIÓN A TUBO 	Número de catálogo	A D. E. Tubo	Rosca Tubo NPTF	B	C	D	E	F	G
	783-FB-0605	3/8	5/16	1.719	1.313	0.750	0.438	0.563	
	783-FB-1206	3/4	3/8	2.078	1.641	1.000	0.250	0.813	
	783-FB-1210	3/4	5/8	2.344	1.719	1.000	0.250	0.938	
	783-FB-1606	1	3/8	2.141	1.703	1.063	0.250	1.063	
	783-FB-1612	1	3/4	2.406	1.781	1.063	0.250	1.063	
752-FB CRUZ 	Número de catálogo	D. E. Tubo	A	B	C	D	E	F	G
	752-FB-05	5/16							
	752-FB-06	3/8	2.719	1.359	0.922				
	752-FB-08	1/2	3.031	1.516	0.969				
	752-FB-16	1							

Refrigeración

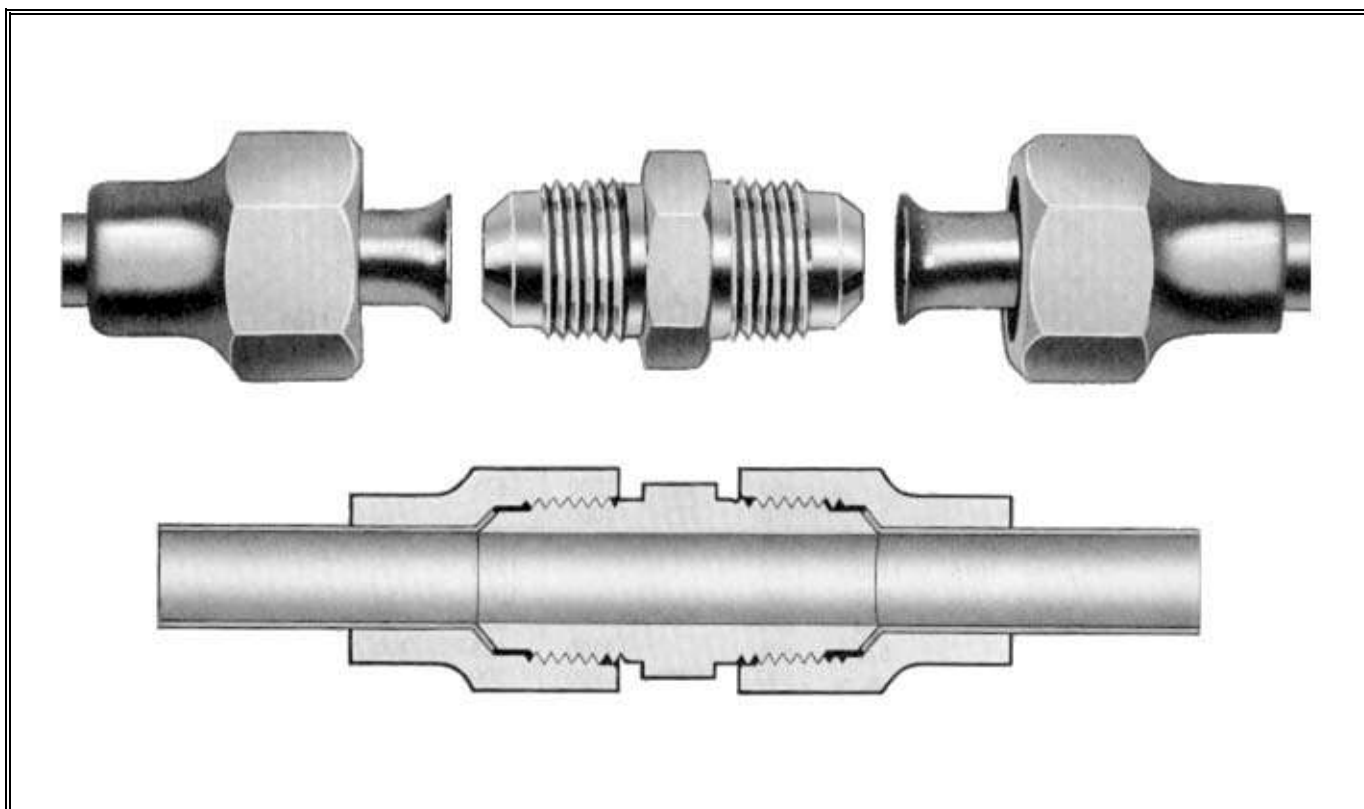

Las tuercas abocinadas forjadas provee extra protección... especialmente en aplicaciones de refrigeración.

TAMAÑO : Tubo : de 3/16" a 3/4" de diámetro exterior.
Terminales de 3/16" a 3/4" NPTF

PRESIÓN MÁXIMA DE OPERACIÓN : 4,600 PSI (323.5 kg/cm²)

MATERIALES : Codos y Tes :
Latón forjado
SAE CA 377
Conectores, uniones, y tuercas : SAE CA 360 o equivalente

COMPATIBILIDAD : Cobre, Aluminio, Latón, acero blando sin costura

ESPECIFICACIONES :

S. A. E. : Cumple S. A. E. J513 Norma para servicio de refrigeración

A. N. S. I. -B31.1 Código para tubería de presión
B70.1 Conexiones de refrigeración para tubo

A. S. M. E. -Código para calderas y ollas de presión

Refrigeración

PRESIONES MÁXIMAS DE OPERACIÓN RECOMENDADAS (PSI)

MATERIAL DE LAS CONEXIONES : LATÓN

MATERIAL DE LA TUBERÍA :

LATÓN

COBRE BLANDO Y COBRE MEDIO DURO

CONDICIONES DE SERVICIO	DIAM. EXT.	TIPO DE TUBERÍA Y GROSOR DE PARED									
		COBRE BLANDO (SIN COSTURA)					COBRE MEDIO DURO (SIN COSTURA)				
		.030"	.032"	.035"	.049"	.065"	.032"	.035"	.042"	.049"	.065"
Factor de Seguridad 4-1	3/16"	2,850		3,300			3,400				
	1/4"	2,100	2,250	2,500			2,500				
	5/16"		1,800	2,000			2,000				
	3/8"		1,500	1,650			1,700	1,850			
	1/2"		1,100	1,250		2,300	1,250	1,400			2,600
	5/8"			1,000	1,400	1,800	1,000			1,500	2,000
	3/4"			850	1,150	1,500			1,100		1,700
Factor de Seguridad 6-1	3/16"	1,900		2,200			2,250				
	1/4"	1,400	1,500	1,650			1,700				
	5/16"		1,200	1,300			1,300				
	3/8"		1,000	1,100			1,100	1,200			
	1/2"		750	825		1,500	850	925			1,700
	5/8"			650	925	1,200	675			1,000	1,350
	3/4"			550	775	1,000			725		1,150
Factor de Seguridad 8-1	3/16"	1,400		1,675			1,700				
	1/4"	1,075	1,100	1,250			1,250				
	5/16"		900	1,000			1,000				
	3/8"		750	825			850	925			
	1/2"		575	625		1,150	625	700			1,300
	5/8"			500	700	900	500			800	1,000
	3/4"			400	575	775			550		850

* Campana de doble abocinado

MATERIAL DE LAS CONEXIONES : LATÓN

MATERIAL DE LA TUBERÍA :

LATÓN

ACERO ESTIRADO EN FRÍO Y ACERO SOLDADO

CONDICIONES DE SERVICIO	DIAM. EXT.	TIPO DE TUBERÍA Y GROSOR DE PARED									
		ACERO S.A.E. 1010 BLANDO ESTIRADO EN FRÍO (SIN COSTURA)					ACERO SOLDADO* (RECOCIDO)				
		.032"	.035"	.049"	.065"	.083"	.095"	.028"	.032"	.035"	.049"
Factor de Seguridad 4-1	3/16"	4,600						4,000			
	1/4"		3,800					3,000	3,500		
	5/16"		3,000	4,300				2,600	2,850		
	3/8"		2,500	3,600				2,000	2,350	2,500	
	1/2"		1,900	2,650	3,500					1,900	2,700
	5/8"			2,100	2,800	3,600				1,500	2,100
	3/4"			1,800	2,300		3,400				
Factor de Seguridad 6-1	3/16"	3,000						2,700			
	1/4"		2,500					3,000	3,500		
	5/16"		2,000	2,900				1,700	1,900		
	3/8"		1,700	2,400				1,350	1,550	1,700	
	1/2"		1,300	1,800	2,300					1,250	1,800
	5/8"			1,400	1,900	2,450				1,000	1,400
	3/4"			1,200	1,550		2,300				
Factor de Seguridad 8-1	3/16"	2,300						2,000			
	1/4"		1,900					1,550	1,750		
	5/16"		1,500	2,200				1,300	1,400		
	3/8"		1,250	1,800				900	1,150	1,250	
	1/2"		950	1,300	1,750					950	1,350
	5/8"			1,000	1,400	1,800				775	1,050
	3/4"			900	1,150		1,700				

* Campana de doble abocinado

Refrigeración

Una conexión para tubo de dos piezas idela para uso en líneas de unidades de proceso, con aceite, líneas instrumentales, unidades de refrigeración móviles o estacionarias.

ROSCAS PARA TUBOS

Rosca larga para tubo Drysel American Standard

INFORMACIÓN PARA PEDIDO

Para hacer un pedido, simplemente indique el número de catálogo y agregue el diámetro exterior y el tamaño de la terminal con rosca para tubo en caso necesario. Las tuercas deben pedirse por separado.

EJEMPLO :

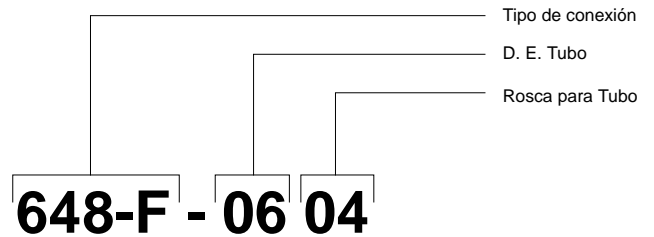

Tubo de 3/8" (6/16") de diámetro exterior x rosca macho para tubo de 1/4" (4/16")
648-F-0604



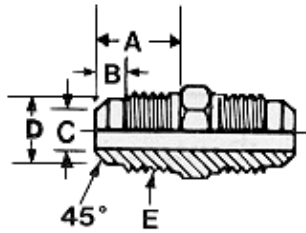

DIMENSIONES DE EXTREMO DEL TUBO

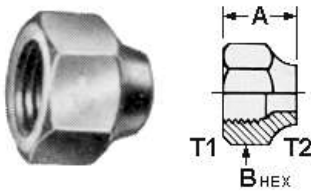
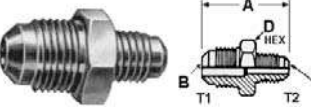
	Diámetro Exterior del tubo	A	B	C	D	Rosca E
	3/16"	0.44	0.12	0.156	0.297	3/8-24
1/4"	0.50	0.16	0.219	0.344	7/16-20	
5/16"	0.56	0.19	0.250	0.406	1/2-20	
3/8"	0.62	0.22	0.312	0.531	5/8-18	
1/2"	0.75	0.25	0.438	0.641	3/4-16	
5/8"	0.88	0.28	0.531	0.750	7/8-14	
3/4"	1.00	0.28	0.719	0.938	1 1/16-14	

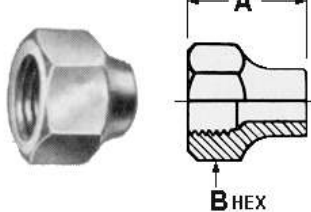
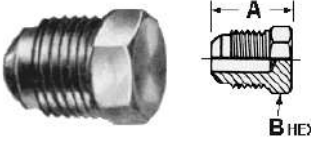
Refrigeración

	Número de catálogo	D. E. Tubo T1	D. E. Tubo T2	A	B	C	D	E	F
662-FS TUERCA REDUCCIÓN CORTA FORJADA 	662-FS-0403	1/4	3/16	0.590	0.625				
	662-FS-0504	5/16	1/4	0.620	0.687				
	662-FS-0604	3/8	1/4	0.690	0.812				
	662-FS-0806	1/2	3/8	0.810	0.937				
	662-FS-1008	5/8	1/2	0.940	1.062				
	662-FS-1210	3/4	5/8	1.120	1.312				
	662-FS-1412	7/8	3/4						
656-F UNIÓN REDUCCIÓN 	656-F-0604	3/8	1/4	1.380	0.281	0.188	0.625		
	656-F-0605	3/8	5/16	1.440	0.281	0.219	0.625		
	656-F-0804	1/2	1/4	1.560	0.406	0.188	0.750		
	656-F-0806	1/2	3/8	1.690	0.406	0.281	0.750		
	656-F-1008	5/8	1/2	2.000	0.500	0.406	0.875		
672-FS ADAPTADOR SOLDABLE 	672-F-0404	1/4	1/4	1.000	0.188	0.437			
	672-F-0606	3/8	3/8	1.190	0.281	0.625			
	672-F-0806	1/2	3/8	1.375	0.406	0.875			
	672-F-0808	1/2	1/2	1.440	0.406	0.750			
	Número de catálogo	D. E. Tubo	Rosca Tubo NPTF	A	B	C	D	E	F
641-FS TUERCA CORTA FORJADA 	641-FS-03	3/16		0.530	0.500				
	641-FS-04	1/4		0.590	0.625				
	641-FS-05	5/16		0.620	0.687				
	641-FS-06	3/8		0.690	0.812				
	641-FS-08	1/2		0.810	0.937				
	641-FS-10	5/8		0.940	1.062				
	641-FS-12	3/4		1.120	1.312				
639-F TAPÓN MACHO ABOCINADO 	639-F-04	1/4		0.690	0.437				
	639-F-05	5/16		0.780	0.500				
	639-F-06	3/8		0.780	0.625				
	639-F-08	1/2		1.060	0.750				
	639-F-10	5/8		1.190	0.875				
	639-F-12	3/4		1.310	1.062				

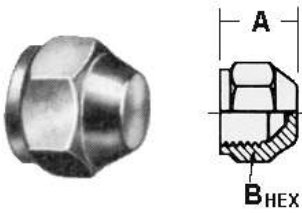
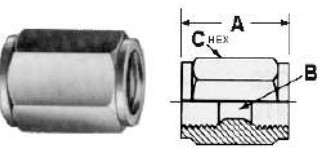
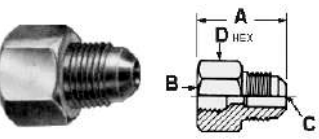
Refrigeración

	Número de catálogo	D. E. Tubo	Rosca Tubo NPTF	A	B	C	D	E	F
640-FB TAPÓN HEMBRA ABOCINADO 	640-FB-04	1/4		0.530	0.562				
	640-FB-06	3/8		0.690	0.750				
	640-FB-08	1/2		0.840	0.875				
	640-FB-10	5/8		0.970	1.062				
660-F UNIÓN HEMBRA 	660-F-08	1/2		1.440	0.500	0.937			
661-F REDUCCIÓN CAMPANA ABOCINADA 	661-F-0406	1/4	3/8	1.120	0.250	0.281	0.625		
	661-F-0408	1/4	1/2	1.250	0.250	0.406	0.750		
	661-F-0604	3/8	1/4	1.220	0.188	0.188	0.812		
	661-F-0608	3/8	1/2	1.410	0.375	0.406	0.812		
	661-F-0804	1/2	1/4	1.380	0.188	0.188	0.937		
	661-F-0806	1/2	3/8	1.440	0.281	0.281	0.937		
	661-F-0810	1/2	5/8	1.620	0.500	0.500	0.937		
	661-F-1008	5/8	1/2	1.690	0.406	0.406	1.062		
	661-F-1012	5/8	3/4	1.880	0.625	0.625	1.062		
	661-F-1210	3/4	5/8	1.970	0.500	0.500	1.312		
215-C ADAPTADOR PARA CILÍNDR 	215-C-0412	1/4	3/4						

LÍNEA INDUSTRIAL

Catálogo de Conexiones Industriales de latón

© Nacobre

Poniente 134 No. 719, Col. Industrial Vallejo, 02300 México, D. F.
Teléfono (01-55) 5728-5300 • Fax (01-55) 5728-5572

Fabrica

Nacional de Cobre, S. A. de C. V.

Planta Toluca

Av. 1° de Mayo No. 1496 Ote.

Corredor Industrial Toluca

50070 Toluca, Edo. de México

Teléfono : (01-722) 214-4388, • Fax (01-722) 214-3949